

# SSL E-Mail/MMS 8MP

Observation camera

Instruction manual



Art. No. 33-40001





**Laser Klasse 1**

**Safety note: CLASS 1 LASER PRODUCT**

This device has been classified as a CLASS 1 LASER product according to IEC 60825-1. The accessible laser radiation is safe under reasonably foreseeable conditions, and under normal conditions of use. Do not open the housing. The device does not contain any parts that can be serviced by the end consumer. Servicing of this unit must be left up to qualified service personnel.

 Visit our website via the following QR Code or web link to find further information on this product or the available translations of these instructions.

 Si vous souhaitez obtenir plus d'informations concernant ce produit ou rechercher ce mode d'emploi en d'autres langues, rendez-vous sur notre site Internet en utilisant le code QR ou le lien correspondant.

 Bezoek onze internetpagina via de volgende QR-code of weblink, voor meer informatie over dit product of de beschikbare vertalingen van deze gebruiksaanwijzing.

 Visite nuestra página de Internet utilizando el siguiente código QR o el enlace web, para buscar más información sobre este producto o versiones disponibles del presente manual de instrucciones en diferentes idiomas.

 Посетите нашу страницу в сети Интернет, используя QR-код или Web-ссылку, для получения дополнительной информации по данному устройству или для поиска доступных языковых версий данного руководства по эксплуатации.



[www.bresser.de/3340001](http://www.bresser.de/3340001)

## General Information

### About this Instruction Manual

Please read the safety instructions in this manual carefully. To avoid damage to the unit and the risk of injury, only use this product as described in the manual. Keep the instruction manual handy so that you can easily look up information on all the functions.

**DANGER!**

You will find this symbol before every section of text that deals with the risk of minor to severe injuries resulting from improper use.

**ATTENTION!**

You will find this symbol in front of every section of text which deals with the risk of damage to property or the environment.

## General Warnings

**DANGER!**

This device contains electronic components which operate via a power source (power supply and/or

batteries). Only use the device as described in the manual, or you run the risk of an electric shock.

Keep batteries out of the reach of children! Make sure you insert the batteries correctly. Empty or damaged batteries could cause burns if they come into contact with the skin. If necessary, wear adequate gloves for protection.

**ATTENTION!**

Do not disassemble the device. In the event of a defect, please contact your dealer. The dealer will contact the Service Centre and can send the device in to be repaired, if necessary. Do not expose the device to temperatures above 60°C.

Do not expose the device to high temperatures. Use only the supplied power supply or the recommended batteries. Do not short-circuit the device or batteries or throw them into a fire! Excessive heat or improper handling could trigger a short-circuit, a fire or an explosion.

Use only the recommended batteries. Always replace weak or empty batteries with a new, complete set of batteries at full capacity. Do not use batteries from different brands or with different capacities. The batteries should be removed from the unit if it has not been used for a long time.

## EC Declaration of Conformity



Bresser GmbH has issued a "Declaration of Conformity" for this device (Observation camera / Art.No.: 33-40001) in accordance with applicable guidelines and corresponding standards of Directive 1999/5/EG.

## DISPOSAL



Dispose of the packaging materials properly, according to their type, such as paper or cardboard. Contact your local waste-disposal service or environmental authority for information on the proper disposal.



Do not dispose of electronic devices in the household garbage! As per Directive 2002/96/

EC of the European Parliament on waste electrical and electronic equipment and its adaptation into German law, used electronic devices must be collected separately and recycled in an environmentally friendly manner.

In accordance with the regulations concerning batteries and rechargeable batteries, disposing of them in the normal household waste is explicitly forbidden. Please make sure to dispose of your used batteries as required by law – at a local collection point or in the retail market. Disposal in domestic waste violates the Battery Directive.

Batteries that contain toxins are marked with a sign and a chemical symbol. "Cd" = cadmium, "Hg" = mercury, "Pb" = lead.



Cd<sup>1</sup>



Hg<sup>2</sup>



Pb<sup>3</sup>

<sup>1</sup> battery contains cadmium

<sup>2</sup> battery contains mercury

<sup>3</sup> battery contains lead

## 1. Instructions

### 1.1 General Description

This digital observation camera, with black IR illumination, works fully automatically. The specific region of interest (ROI) is monitored by a high sensitive Passive Infrared (PIR) motion sensor and can be triggered by the slightest movement of either human or animal thus leading to automatic exposure of high quality pictures (up to 8MP interpolated) or recording of video clips (VGA) according to default settings or preset customer settings. Images can then be directly forwarded to your mobile phone or by email via GSM/GPRS network. The automatic messaging function sends you information when photos or videos are triggered.

Colour photos and videos are possible when sufficient light is available. In darkness the integrated infrared LEDs illuminate the region of interest while the camera photographs (monochrome). It's novel patented IR illumination is not visible to animals and humans and has a range of up to 18 meters.

The camera is water and snow resistant thus being ideal for outdoor use. Furthermore, it can be used as a portable digital camera.

Manual pictures and videos can be taken by pressing  on the remote control (please note that the "TEST" mode needs to be activated as well as an SD-card inserted.)

### Intended use

This surveillance camera is used for monitoring objects or places (eg rooms, door and entrance areas, driveways and wildlife, watching at feeding grounds, the feeding place or deer crossing) with photo or video.

The camera is waterproof (IP44 rating) and thus not only suitable for indoor surveillance, but also for mounting in a protected spot outside.

Through motion, the integrated PIR sensor triggers a photo or video that is stored on a memory card. The photo can be sent via MMS or email. If the ambient light is too weak, the surveillance camera automatically turns on the built-in infrared lighting and the camera turns for better sensitivity into b / w mode.

The camera is powered by batteries. For stationary surveillance the camera can also be powered by an AC adapter\*. However, the network device\* must be protected from moisture and humidity.

The surveillance camera is designed exclusively for use in private households. Any other use or modification of the camera is considered improper use and could give rise to considerable dangers. The manufacturer is not liable for damage caused by improper use or incorrect operation.

## 1.2 Included in delivery (Fig. 1)

- ❶ Digital camera
- ❷ Antenna
- ❸ Remote control
- ❹ USB cable
- ❺ Belt
- ❻ Assembly accessories



## 1.3 Camera I/O Interfaces

The camera has the following I/O interfaces: Mini USB connector, SD-card1 slot, TV output, SIM card1 slot and

external DC power connector.

There is a small hole in the battery compartment where one can attach a lock for theft-protection.

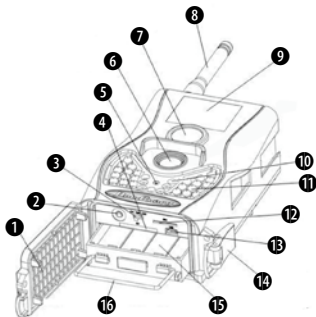

1. Bottom Cover
2. TV-out connector
3. Power switch
4. SD-Card slot
5. Laser pointer
6. Camera lens
7. PIR (Passive Infrared motion sensor )

8. Antenna
9. LCD Display
10. Indication LED's
11. IR illumination
12. SIM card slot
13. USB connector
14. Lock
15. Battery compartment
16. Battery depot handle

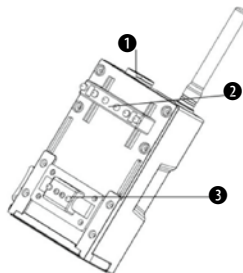

1. DC power connector
2. Tilt adjustment
3. Theft-protection lock

\*not included with your purchase

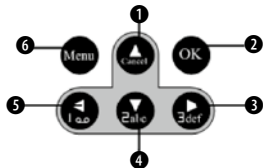

## 1.4 Remote Control

Camera settings can be adjusted using the remote control. The wireless infrared device has a reception range of up to 9 meters.

### Please note:

It can take up to 20 seconds, after the camera has been switched on, before it receives signals from the remote control.

The remote control has 15 function keys.

1. <Cancel> Select item (UP), Increase value
2. <OK> Make selection (OK)
3. <3def> Select option (RIGHT)
4. <2abc> Select item (DOWN), Decrease value
5. <1> Select option (LEFT)
6. <Menu> Display menus, Exit (MENU)

### 1.4.1 Navigation

#### Please note:

In order to navigate through the camera's menu with the remote control, an SD-card must be inserted and „TEST“ mode must be activated (power switch in „Test“ position).

1. Press „Menu“ on remote control to start camera menu.
2. Press ▲ or ▼ keys to switch between the different menus.
3. Press ▢ or ▣ keys to switch from a submenu to another menu point.
4. Press „OK“ key to make a selection.



### 1.4.2 Entering special characters

Some helpful special characters may be entered using the following key combinations:

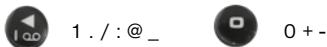

### 1.5 Camera Display

After the camera has been switched on (power switch set to „ON“ or „TEST“ position), the following information will be shown on the display.

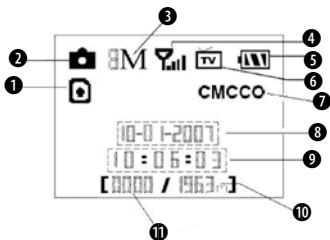

1. SIM-Card
2. Camera mode
3. Image resolution

4. Signal strength
5. Battery level
6. TV-connection
7. Mobile network provider
8. Date (Month/Day/Year)
9. Time (Hours/Minutes/Seconds)
10. Maximum numbers of images (according to the memory capacity available)
11. Number of captured images

### 1.6 e-Mail/MMS Function

#### IMPORTANT:

In order to avail of this function, it's necessary to have a mobile network provider<sup>1</sup> as well as a suitable SIM-card<sup>1</sup>. The extra costs generated are dependent on the rates and conditions of your provider.

Prepaid cards may also be used. Please note that it is only possible to recharge credit through your mobile phone and not directly from the camera. The camera operates mobile networking on the following frequencies: 850 MHz, 900 MHz, 1800 MHz and 1900 MHz. For more information please read the section on „MMS Settings“.

\*not included with your purchase

<sup>1</sup>) For information on correct mail settings, please contact your email provider.

<sup>2</sup>) For information on GPRS mobile settings, please contact your mobile provider.

This camera can send images to your mobile device via GSM/GPRS mobile network<sup>1</sup>. It's also possible to program the camera to inform you daily when the camera is activated.

Once you have inserted a SIM-card one of the following icons is displayed:



SIM-card inserted and functional.



SIM-card inserted but not functional due to lack of signal or other error of communication.

If no SIM-card is inserted no icon appears.

**Please note:**

Deactivate the PIN code query before inserting the SIM-card. This can be done via the settings menu of your mobile phone. It is not possible to deactivate the query directly via the camera.

There are 4 possible settings for the email and MMS function: „Send Mode“, „MMS Set“, „GPRS Set“ and „Send to“. Using the “Send Mode” you can determine when you get an automatic message by camera exposure (see table in section on “Settings”). The extent of the functionality of the “MMS Set” and “GPRS Set” is dependant on the services available through your mobile phone provider. When using the “Send to “ option, simply enter the correct mobile phone number or email address where the camera should forward the images to.

**Beachten Sie:**

The SSL/TLS encryption for sending emails is supported by this device. Some providers require this setting activated in order to send emails. Please ask your Internet provider whether this function is required.

## 1.7 Supported formats

Important! Which file system you use for your SD-card is normally not relevant, however one can experience difficulties reading data from the card. In this situation please format the card again either in the camera or on your computer and it's ready for use.

Item	Format
Image	JPG
Video	AVI
File format	FAT32

## 2. Important Safety Instructions!

- The working voltage of the camera is 6V. The camera is supplied with 2 x 4 AA type batteries.
- Please install batteries according to polarity displayed.
- For camera operation an SD-card\* (8 MB to 32 GB) is necessary.
- Please unlock the write-protection function before inserting the SD-card.
- Please insert the SD-card before testing the camera and ensure the power switch is at the OFF position. The camera has no internal memory for saving images or videos.
- Do not insert or remove the SD-card\* or SIM-card\* when the power switch is at the ON position.
- When first in use it is recommended to format the SD-card via the camera.
- The camera automatically changes to USB mode when connected to the USB port of a computer. In this case, the SD-card\* functions as an exchangeable memory device.
- In the TEST mode the camera shuts down automatically after 3 minutes if not in use. In this situation it's necessary to switch the power back on in order to continue working with the remote control.

\*Not included with your purchase

- The red filter in front of the lens moves automatically when needed. It might seem to have no real function the way it hangs halfway over the lens. However, this is not a camera defect as long as the image quality remains unaffected.

## 3. Basic Operations

### 3.1 Power supply

2x4 AA type batteries are necessary for power supply for the camera. Optionally, the device may be powered through an external power supply (extra accessory).

This manual only describes use with battery power supply.

#### **ATTENTION!**

The manufacturer does not take liability for any damage caused by the wrong insertion of batteries or by the use of a non-compatible power supply!

Open the bottom cover.

#### **ATTENTION!**

Make sure that the power switch is at the OFF position.



Using the handle open the battery compartment and pull it out.

Insert fully charged batteries into the compartment according to the polarity shown in the battery slots. Always insert two batteries with the same polarity in each slot. The following batteries with 1.5V output can be used:

1. High-density alkaline batteries (recommended) or Lithium ion batteries
2. Rechargeable alkaline batteries
3. Rechargeable NiMH batteries

There are 4 battery slots.

Two slots are combined to one group. The slots of the two groups are marked with "1" and "2". For normal power supply only one group is needed but however it is recommended to insert batteries in all the slots.

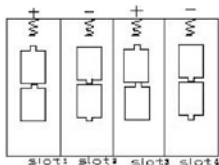

When the batteries are low the camera automatically shuts down after two indication sounds. Please change the batteries in time. Remove used batteries from the device immediately! If the "Send" function is activated, you will be informed about low-battery-status.

### 3.2 Inserting the SD-card and SIM-card

Open the bottom cover. Insert the SD-card\* into the card slot with the unmarked side facing upwards. Please note

that the card can only be inserted in one direction. Make sure that the write-protect switch of the SD-card is in the "write" position as otherwise the camera cannot be switched on.

To use MMS/SMS or eMail functions, a suitable SIM-card\* must be inserted into the available card slot.

#### **IMPORTANT:**

This device operates only with Mini SIM-cards\*. Micro SIM-cards and Nano SIM-cards\* are not compatible. Please contact your mobile network provider for further information about suitable Mini SIM-cards.

### 3.3 Switching the camera on

Before switching on, please pay attention to the following:

1. Avoid temperature and motional disturbances in front of the camera; for example air-conditioner, chimney or other heat sources. This can have a negative effect on the camera's trigger function.

2. Select the camera location according to the objects under observation. A height of 1-2 metres is generally recommended.
3. Switch on the camera by sliding the power switch to the ON position.

**Hint:**

Before using the camera, you can use the integrated laser pointer to align the camera to the required monitoring area. Read more in section on “Aligning the camera”.

After switching the camera on, the red LED indicator blinks for approximately 10 seconds. This buffer allows you to locate the camera according to wish. After the 10 seconds the camera automatically functions capturing images or videos according to the selected mode.

**IMPORTANT:**

The remote control cannot be used when the camera is in the “ON” position. The camera automatically captures images or videos according to setting.

**3.4 TEST function**



In order to capture user-defined imagery one can adjust the settings by using the “TEST” function of the camera. This is done by turning the power switch from the “OFF” or “ON” position to the “TEST” position.

Various features such as user-defined settings, manual photography, preview or manual MMS messaging can be selected accordingly through the remote control.



**Hint:**

The settings for automatic image capturing, MMS messages, etc., are deactivated when the camera is switched to “TEST” mode.

### 3.4.1 Manual use

In TEST mode it is possible to capture pictures or videos manually by pressing the  button on the remote control. Use the  button to stop the manual recording.

### 3.4.2 View images or videos

Press OK to enter image storage. Press  key to view the previous image or  key for the next. Please note: Videos cannot be played on the LCD screen and only thumbnails of the videos are shown.

Detailed information of operations like deleting images or videos is described in the section “Advanced Operations”.

### 3.4.3 Sending messages via MMS or by e-Mail

If the option “Manual” under menu point “Send mode” is selected, images can be send to the set address. The settings for “Daily report” and “Instant” under menu point “Send mode” can only be used in the “ON” mode.

### 3.4.4 Switching off

Turn the power switch to the OFF position to switch the camera off. Please note that even in the OFF mode, the camera still consumes certain power at  $\mu\text{A}$  level. Therefore, please remove the batteries if the camera will not be used for a while.

## 4. Advanced Operations

We know from the basic operations of the camera in the previous chapter, that the camera has three basic operational modes:

1. **OFF Mode:** Power switch is in OFF position.
2. **ON Mode:** Power switch is in ON position.
3. **TEST Mode:** Power switch is in ON position and the remote control is connected to the camera.

The OFF mode is a specific safety mode for replacing the SD-card or batteries and transporting the camera.

**ATTENTION:** Replace the SD-card\* and SIM-card\* only in the OFF mode!

## 4.1 Settings

In order to avail of specific settings the remote control has to be connected and a SD-card inserted. Now you can change to the “TEST” mode explained before. Press MENU on the remote control to open the “Settings” menu on the camera’s display.

Language	Selecting the menu language
Camera Mode	Choice of function (Imagery or video)
Default Set	Resets all customer settings to default values
Send To	Select a setting to send images to your mobile phone or by e-Mail: <ol style="list-style-type: none"><li>1. Mobile phone (MMS): Send an image to a mobile phone via WAP</li><li>2. Email (MMS): Send an image to an E-Mail address via WAP</li><li>3. Email (GPRS): Send an image to an E-Mail address via SMTP. This method of messaging is much cheaper in some countries.</li></ol>



<p>Send Mode</p>	<p>4 different dispatch modes: „Manual“ for the function in TEST mode, „Daily Report“ or „Instant“ for the function in ON mode.</p> <p><b>IMPORTANT:</b> Ensure that a fully functional SIM-card is inserted.</p> <ol style="list-style-type: none"><li>1. „Manual“: Select „Manual“ when using the TEST mode. Only single images can be sent with this function. Videos cannot be sent.</li><li>2. “Daily Report”: This function is only available in the ON mode. The camera sends a text message at a specific time with information about captured images or videos up to that point. If image capturing is set, you will receive a MMS message with the last image as well as information about the complete number of images that had been captured during the last 24 hours.</li></ol>	<p>If video recording is set, you will get a message with information about the complete number of videos that had been captured during the last 24 hours.</p> <ol style="list-style-type: none"><li>3. “Instant”: This function is only available in the ON mode. The camera sends a picture each time when a new image or video had been taken. It's possible to select the number of images that should be sent each day. If you select a maximum number of “10”, the camera will send the first 10 images. All other images will be stored on the SD-card.</li><li>4. “OFF”: Disable Send function.</li></ol>
------------------	---	---

GPRS Set	Settings for sending e-Mails via GPRS mobile network. In order to send e-Mails, one has to have the correct GPRS settings (for example server port, APN, etc.). If you are not familiar with these settings, please contact your mobile and e-Mail provider for further information and assistance.
MMS Set	The camera sends MMS messages via the GPRS mobile network. However, your mobile phone provider must activate the GPRS service. The camera supports the following 4 transmission frequencies (Quad-Band): 850 MHz, 900 MHz, 1800 MHz and 1900 MHz. In order to send MMS messages the camera must have the correct settings activated (for example URL, APN, IP and Port). Please contact your mobile phone provider should you have difficulties activating these settings.
Timer Switch	The camera can be activated for a certain period of a day. The camera is switched off the rest of the time.

Sense Level	Choose sensitivity of PIR (Passive infrared motion sensor). The higher the setting, the easier the motion sensor activates triggering. It is recommended to use Normal mode. The sensitivity of the PIR is strongly related to temperature. High temperatures reduce sensitivity. Therefore, you may need to adjust the sensor level to an appropriate value.
PIR Interval	Choose how long the camera should stop functioning after each triggering. The camera's PIR is disabled during this interval. If the "Time Lapse" function is used, the OFF mode must be set.
Version	Query on the firmware version and the IMEI number.
Video Length	Choose duration of recording videos.
Photo Burst	Choose the number of continuous shots after each triggering.

Set Clock / Date	Set camera date and time.
Video Size	Choose the video resolution, e.g. 640×480 (VGA).
Photo Size	Choose the image resolution, e.g. 8MP or 5MP.
Format	Format the SD-card. All images and videos on the SD-card are deleted.
SMS control	If enabled, you can control the camera via SMS text message from your mobile phone, or retrieve settings.
Time Lapse	The interval for triggering the camera can be adjusted. 5 minutes - 8 hours.

### 4.1.1 Default Settings

Default settings are listed below:

Setting Items	Default settings	Options	Submenu
Language	Englisch	English, German, Suomi, Svenska	
Camera Mode	Image	Video	
Default Set	Enter		
Send To	Phone via GSM (MMS)	Email via GSM (MMS) Email via GPRS	
GPRS Set	Enter		Server, APN, Port
MMS Set	Enter		URL, APN, IP, Port
Timer Switch	Off	On	Start, Stop (00:00 - 23:59)
Sense Level	Normal	High, Low, off	
PIR Interval	1 Minute	0-59 seconds, 1-60 minutes	
Video Length	Avi 10 seconds	Avi 1-60 seconds	
Photo Burst	1 Photo	2 Photos, 3 Photos	

Set Clock	Enter		Adjust Clock
Video Size	1280x720	640x480	
Photo Size	8MP (Megapixel)	5MP (Megapixel)	
Format	Enter		Yes, No

#### 4.1.2 Set camera mode

There are two ways to set the camera mode:

1. Via shortcut key: Press **▲** to set the camera mode to VIDEO or press **▼** to set the camera mode to Photo.
2. Via Settings menu: The following shows how to set the camera mode to VIDEO, provided that the previous mode was PHOTO::
  - a) Press MENU to display the setting menu.
  - b) Press **▲** to select MODE to change current mode.
  - c) Press **▶** to select VIDEO.
  - d) Press OK to save the current setting.
  - e) Press MENU to cancel setting and return to info display

#### 4.1.3 Setting the menu language

The following steps describe the setting of the menu language to German, provided the previously set language is English:

- a) Press MENU to display the set-up menu.
- b) Press **▲** or **▼** to select LANGUAGE
- c) Press **▶** to select German.
- d) Press OK to save the current setting
- e) Press MENU to cancel setting and return to info display.

#### 4.1.4 Reset to default settings

Follow these steps to reset to default values:

- a) Press **MENU** to display the set-up menu
- b) Press **▲** or **▼** to select **RESET**.
- c) Press **OK** to reset to default settings and return to info display.
- d) Press **MENU** to cancel setting and return to info display

##### **Notice:**

After restoring the factory settings, the menu language is set to English. To change the menu language, see the description "Setting the menu language".

#### 4.1.5 Set message recipient (Send To)

Here you can type in the mobile phone number or email address of the MMS recipient. The following steps describe how to setup MMS messaging to a mobile phone (PHONE (MMS)), assuming that the previous option was EMAIL (MMS):

- a) Press **MENU** to display the set-up menu.
- b) Press **▲** or **▼** to select **SEND TO**.
- c) **■** to select **PHONE** via GSM (MMS).
- d) Press **OK** to display the submenu.
- e) Four input fields are available for selection.  
You can switch between the input fields by pressing the **#** button.  
Press any keys to enter the necessary numbers, letters or special characters.  
- or -  
Press **■** to delete your input.
- f) Press **OK** to save the settings and return to info display.

#### 4.1.6 Dispatch (Send Mode)

You can choose between 3 different dispatch options: Use the “Manual” option when using the camera in “TEST” mode. The 2 other options, „Daily Report“ and „Instant“, can only be used when the “ON” mode is set. For further information on these functions, please read the section on “Settings”.

The following steps describe how to install the dispatch option “Instant”, provided the camera is set to “OFF”.

- a) Press **MENU** to display the set-up menu.
- b) Press **▲** or **▼** to select **SEND MODE**.
- c) Press **■** to select the option „Instant“.
- d) Press OK to enter the submenu
- e) Press **▲** to determine the maximum amount of images to be transmitted. You have a choice between the following predefined options: 00-99 or unlimited.
- f) Press OK to save settings and exit the set-up menu.

#### Please note:

For “Daily Report” dispatch, the camera requires information on the length of time, in hours and minutes, which it should transmit.

#### 4.1.7 GPRS/Email Set-up (GPRS Set)

#### WICHTIG:

The automatic configuration of this device using SMS configuration data is not possible. The configuration must be done manually.

The following steps describe what parameters are necessary in order to set up email dispatch via GPRS connection:

- a) Press **MENU** to display the set-up menu.
- b) Press **▲** or **▼** to select **GRPS-SET**.
- c) Press **ENTER** to enter the submenu.
- d) The following entry fields must be completed:  
Server1): Name of email Server (for example smtp.domainname.de)

Port<sup>1)</sup>: Port of email Server (for example 25)

APN<sup>2)</sup>: Your mobile provider's Internet APN (for example web.providername.de)

Account and Password<sup>2)</sup>: Most mobile providers require extra user's name and password in order to avail of their mobile Internet service.

Email User<sup>1)</sup>: User name

Email Password<sup>1)</sup>: Email password.

You can switch from one entry field to another using the # key. Use the numeric keys to enter numbers, letters or special characters.

- or -

Press **DEL** to delete the entry.

e) Press **OK** to save settings and exit the set-up menu.

#### **Please note:**

Set-up can also be undertaken via computer. Further information can be found in the section on Setting the camera with the configuration software.

## **4.1.8 MMS Set-up**

### **IMPORTANT:**

It is not possible to automatically configure the device through transmission of data via SMS. The configuration has to be undertaken manually.

Follow these steps to enter the necessary set-up parameters<sup>2)</sup> for MMS dispatch:

- a) Press **MENU** to display the set-up menu
- b) Press **▲** or **▼** to select **MMS SET**.
- c) Press **ENTER** to enter the submenu.
- d) The following entry fields must be completed:
  - URL: URL for the MMS service (max. 64 characters)
  - APN: Internet APN of your mobile provider (max. 32 characters)
  - IP: The IP-address of the MMS servers (max. 16 characters)
  - Port: MMS server port (max. 6 characters)
  - Account and Password<sup>2)</sup>: Some mobile providers require extra user's name and password in order to avail of their MMS service.

1) Please request information on set-up details from your email provider.

2) Please request information on GPRS mobile networking from your mobile provider.



Use the numeric keys to enter numbers, letters or special characters.

- or -

Press **⬅** to delete the entry.

e) Press **OK** to save settings and exit the set-up menu.

#### **Please note:**

Set-up can also be undertaken via computer. Further information can be found in the section on "Easy set-up for GPRS/Email and MMS functions".

### **4.1.9 Setting timer**

The setting steps are similar to **SET CLOCK**. Please note that the start and stop time (24h clock) can only be effective when the timer is set to **ON**. Assuming that the camera should work from eight a.m. to five p.m., the steps are as following:

- Press **MENU** to display the set-up menu
- Press **⬅** or **➡** to select **TIMER SWITCH**.
- Press **⬅** to select **ON**.
- Press **OK** to enter into submenu.

d) Press **⬅** to select item, press <Pfeil oben> or <Pfeil unten> to change the value.

f) Press **OK** to save all current setting

g) Press **MENU** to return to previous menu

### **4.1.10 Set PIR sensitivity**

**Note:** It is recommended to use **NORMAL** mode.

The following steps show how to set PIR sensitivity to Low provided that the previous option is **NORMAL**. If "Time Lapse" is used, the **OFF** mode must be set.

- Press **MENU** to display the set-up menu.
- Press **⬅** or **➡** to select **SENSOR LEVEL**
- Press **⬅** to select **LOW**, **HIGH** or **OFF**.
- Press **OK** to save the current setting
- Press **MENU** to cancel setting and return to info display.

#### 4.1.11 Set triggering interval time

Press **▲** to decrease or increase the value by 1 second or 1 minute.

The following steps show how to set the triggering interval time to 5 MINUTES provided that the previous value was 1 MINUTE.

- Press MENU to display the set-up menu.
- Press **▲** or **▼** to select INTERVAL.
- Press **▲** to decrease or increase to 5 MINUTES.
- Press OK to save the current setting.
- Press MENU to cancel setting and return to info display.

#### 4.1.12 Setting the time-lapse interval

This camera offers the option to record time-lapse videos. The following steps describe how to activate the time-lapse function.

- Press MENU to display the set-up menu.
- Press **▲** or **▼** to select Time-Lapse.
- Press **▲** or **▼** to select Off.
- Press OK to save current settings.
- Press MENU to exit.

#### 4.1.13 Set video length

Press **▲** to decrease or increase the value by 1 second. The following steps show how to set video length to 5 SECONDS provided that the previous value was 1 SECOND:

- Press MENU to display the set-up menu.
- Press **▲** or **▼** to select VIDEO LENGTH.
- Press **▲** to increase to 5 SECONDS.
- Press OK to save the current setting.
- Press MENU to cancel setting and exit.

#### 4.1.14 Set photo burst





The following steps show how to set continuous capture number to 3 IMAGES provided that the previous option was 1 IMAGE:

- Press MENU to display the set-up menu.
- Press **▲** or **▼** to select PHOTO BURST.
- Press **▲** to select 3 IMAGES.
- Press OK to save the current setting.
- Press MENU to cancel setting and return to info display.

#### 4.1.15 Set date and clock



The date format is month/day/year, the time format is hour/minute/second (24h clock).

The valid settings lie between 2006 and 2031. Default setting may vary from the current date. Provided that date and time settings need to be changed, the steps are as follows:

- a) Press MENU to display the set-up menu.
- b) Press  or  to select SET CLOCK/DATE.
- c) Press OK to enter into submenu.
- d) Press  to select item, press  or  to change the value.
- e) Press OK to save all current settings and return to info display.
- f) Press MENU to cancel setting and return to info display.

#### 4.1.16 Set video size



The following steps show how to set video size as 1280x720 provided that the option is set to 640x480:

- a) Press MENU to display the set-up menu.
- b) Press  or  to select VIDEO SIZE.
- c) Press  to select 1280x720.

- d) Press OK to save the current setting.
- e) Press MENU to cancel setting and return to info display.



#### 4.1.17 Set photo size

The following steps show how to set photo size to 5MP provided that the option is set to 8MP:

- f) Press MENU to display the set-up menu.
- b) Press  or  to select PHOTO SIZE.
- c) Press  to select 5MP.
- d) Press OK to save the current setting.
- e) Press MENU to cancel setting and return to info display.

#### 4.1.18 Format SD-Card

**ATTENTION:** Formatting deletes all images or videos stored on the SD-card. Please ensure that you have a back-up of all important data.

- a) Press MENU to display the set-up menu.
- b) Press  or  to select FORMAT.
- c) Press OK to enter into the submenu.

- d) Press **▶** to select YES.
- e) Press OK to start formatting the SD-card. During formatting, the display screen will show a message "Please wait!" as below.
- f) Press MENU to cancel setting and return to info display.



Please Wait!

#### 4.1.19 Version and IMEI-Number





- a) Press MENU to display the set-up menu.
- b) Press **▶** or **◀** to select VERSION.
- c) Press OK to view the Version and IMEI-Number.
- d) Press MENU to cancel setting and return to info display.

#### 4.1.20 View image or video

- a) Switch to TEST mode and enter into info display.
- b) Press OK to view previous image or video
- c) **Please note:** It is not possible to play the recorded videos on the camera's display. Only a preview is possible. Press **▶** to play the selected video on a TV-Monitor.
- d) Press **▶** to stop the playback and to return to the menu.
- e) Press **▶** to view the next picture (or video) and **◀** for the previous.
- f) Press OK to return to info display.

The total number of all images on the SD-card, as well as the index number of the displayed image, are shown respectively when viewing the images.

#### 4.1.21 Delete image or video



- a) Switch to TEST mode.
- b) Press OK to display the last Image or Video.
- c) Press MENU to display the Send/Delete menu.
- d) Press  or  to select Delete.
- e) Press  or  depending on whether you want to select DELETE ONE (delete selected image) or DELETE ALL (delete all). The option DELETE ONE is pre-selected.
- f) Press OK. NO and YES are prompted. NO is highlighted.
- g) Press  to highlight YES.
- h) Press OK to delete the image or video.
- i) Press MENU to cancel and return to playback.

**ATTENTION:** After deleting a picture or a video file, the deleted files can't be restored! Furthermore, in order to delete all images and video clips on the SD-card, it is recommended you format the SD-card.

#### 4.1.22 Manual MMS and Email Dispatch

##### IMPORTANT:

This function only operates when the camera is switched to TEST mode. Furthermore the option "Manual" must be selected in the "SEND MODE" menu.

- a) Press OK to view the last image (or video).
- b) Choose an image that you would like to send.
- c) Press MENU to display the option SEND MESSAGE.
- d) Press  or  to select SEND MESSAGE.
- e) Press OK to send the image to the mobile number or email address required.
- f) Press MENU to cancel and return to image/video display.

##### Please note:

It is only possible to send photo images. An active SIM card is required.

#### 4.1.23 Laserpointer

The integrated laser pointer allows you to precisely align the camera to the specific object under observation.

- a) Change to TEST mode.
- b) Press the \* key to activate or deactivate the laser pointer.
- c) Adjust the camera according to requirements using the tilting option located at the back of the camera

**WARNING:**

Do not look directly at the laser beam. The high concentration of light can cause irreparable eye damage.

**4.2 File numbering**

Images and videos are saved in the pre-named folder. File numbering continues by adding one to the last number for each new image or video. The files are saved using names like IMAG0001.JPG or IMAG0001.AVI. Through the suffix you can distinguish whether the file is an image (with suffix .jpg) or a video (with suffix .avi).

## 4.2 Set the camera settings with the configuration software BMC CONFIG

The configuration software „BMC Config“ is available from our website.

DOWNLOAD: <http://www.bresser.de/3340001>

Start the application BMC\_CONFIG.EXE



Select the model SG880MK-8MHD. Enable the "Remember My Choice", so that the correct model is selected the next time the program starts. Then click with the mouse on "OK (Y)".



## Camera Setting

Camera Mode	Choose the camera mode (Picture or Video)
Language	Select the menu language
Video Size	Set the video resolution
Photo Size	Set the photo resolution
PIR Interval	The interval for triggering of the camera can be adjusted. This means how quickly after taking the first picture the next picture will be taken. The motion sensor of the camera is then turned off for the specified period in between.
SMS Control	If enabled, you can control via the camera by SMS text message on your mobile phone, or retrieve status data.
Photo Burst	Specifies the number of images that will be taken after the trigger is activated.
Video Length	The recording time of the video can be adjusted.
Time Lapse	The interval for triggering the camera in time lapse mode can be set. 5 minutes - 8 hours.



PIR Trigger	Here the sensitivity of the motion sensor can be adjusted.
Work Hour	Here, you can set a specific date range in which the camera should be active. Out of the specified period, the camera is then inactive.
Set Clock	Set the current date and time. WAP Setting / Internet Setting
Send Mode	Set the delivery mode
Send To	Select a setting for the image delivery to a mobile phone or via e-mail.
Select Country	Select the country where you want to use the camera. There you are then proposed with provider for mobile communications in the field "Select Operator".
Select Operator	Select your provider for mobile communications. If your provider is not listed, select "Other". After selecting your provider, click with the left mouse button on the icon "Check WAP / Internet Parameters" the window "/ WAP Internet Parameters" will open. Please check the default values and complete the parameters for your e-mail provider.

## WAP / Internet Parameters

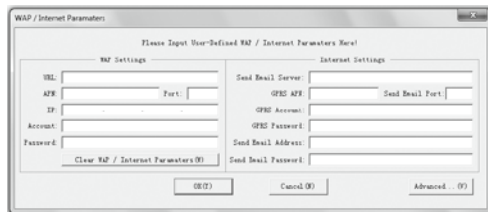

### WAP Setting

- URL<sup>2)</sup>: URL for the MMS-Service
- Port<sup>2)</sup>: Port of the MMS-Server
- APN<sup>2)</sup>: MMS APN of your mobile provider.
- IP<sup>2)</sup>: IP-Adress or MMS-Server

Account, Password<sup>2)</sup>:

For some mobile networks a specific user name and password must be entered for the MMS usage.

## Internet Setting

Send Email Server<sup>1)</sup>: Name of the E-Mail-Server (z.B. smtp.domainname.de)

Send Email Port<sup>1)</sup>: Port of the E-Mail-Server (z.B. 25)

GPRS APN<sup>2)</sup>: Internet APN of your mobile provider

GPRS Account and GPRS Password<sup>2)</sup>: For most mobile networks, a special user name and password must be entered to use the mobile Internet.

Confirm your entries by clicking on the icon "OK (Y)".

The program saves the settings and exits the menu.

To exit the menu without making changes, click on the icon "Cancel (N)".

## Advanced Setup

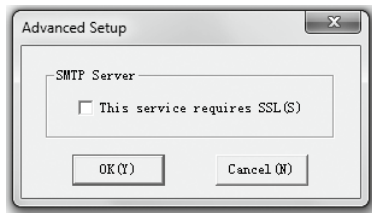

The outgoing mail server of your email provider uses SSL encryption, in this menu select the "This service requires SSL (S)" function.

Confirm by clicking on the icon "OK (Y)". To exit the menu without making changes, click on the icon "Cancel (N)".

Once you have entered and checked all the parameters, select the field "Attention Please, The Data Above Will Be Saved In The Following File" to save the configuration file and click on the icon "Save". Exit the program by clicking on the icon "Exit (N)".

1) For information on correct mail settings, please contact your email provider.

2) For information on GPRS mobile settings, please contact your mobile provider.

Copy the configuration file

Connect the camera via the supplied USB cable to your computer. The contents of the memory card will appear as an external disk in the computer. Save the file under the same name and in the GSM directory (top level) on the memory card. Disconnect the connection between memory card and computer with the function "Media Eject" and disconnect the USB cable afterwards.

**IMPORTANT:**

Make sure that new batteries, an SD card and a SIM card have been inserted into the camera.

## 5. Detection range of the Motion Sensor

The following diagram shows the detection range of the motion sensor at different distances. At a distance of 15 metres (50 feet) the angle of detection is  $35^\circ$ . At a distance of 9 metres (30 feet) the angle of detection is  $52^\circ$ .

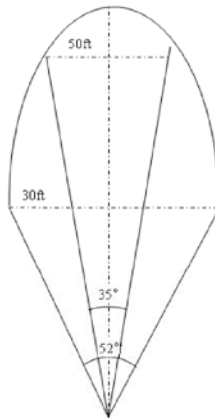

## 6. Aligning the camera

Use the rocker on the back of the camera to align. There are three ways to align the camera optimally:

### 1. Alignment using the laser pointer:

Point the remote at the camera and press the \* key on the remote control to set the laser pointer to on or off (while in test mode). The bright red dot of the laser pointer marks the center of the image.

**CAUTION:** Laser pointer can cause damage to the retina of the eye. Never look directly into the laser pointer.

### 2. Alignment using the PIR sensor:

When the camera is in test mode, the power indicator flashes red each time a movement is registered. Walk around in the area to test the detection range of the motion sensor to align the camera.

### 3. Alignment using the photo trigger manually:

Point the remote at the camera and press  on the remote control to manually trigger a photo. Press OK to display to the most recent photo on the LCD display. Adjust the camera alignment with the help of the photo.

### **Note:**

Avoid direct backlighting. Therefore, position the camera so that you can adjust the camera direction to north or that the camera is in shadow.

### **Respect privacy!**

The device is intended for your personal use. Respect others privacy - do not use the device to look into other peoples homes or buildings, public spaces, along walking and hiking trails or on heavily frequented places.

### **SMS control**

When the camera is in "ON-mode" and the SMS control is enabled, you can, for example, send the SMS message "#t#e#" to the phone number on the SIM card in your camera to get a recent photo send to your e-mail.

### **Note:**

The phone number of the mobile phone that you use to send SMS control commands must be entered as the first number on the list of phones for the MMS dispatch.

### **SMS Command List**

Below is a SMS command list.

No.	Function	SMS Commands
1	Set the Super User	#sg880#4321# Recipient Phone Nr. Supper User #
2	Set the MMS Parameters	#m#URL#IP#Port#APN#APN account#APN password#
3	Set the GPRS Parameters	#s#Email user#Email password #Port#APN#Emai Server# APN account# APN password#
4	Set the recipient Phone number	#n#Recipient Phone Nr. 1# Recipient Phone Nr. 2# Recipient Phone Nr. 3#
5	Set the recipient e-mail address	#r#Recipient Email1# Recipient Email2# Recipient Email3#
6	Receiving an Individual Photo	#t# (Send via MMS) #t#e# (Send via E-Mail) (GPRS)
7	Check the camera settings	#L#

8	Set the camera Parameter	#e#camera mode#photo size#video size#photo burst#video length#set clock#time lapse#pir trigger#PIR interval #send to#work hour#
9	Format the SD-Card	#F#
10	Set the Administrator Password	#P#0000#
11	Help	#H#

Note:

All SMS commands begin and end with "#".

## 7. Troubleshooting

### 7.1 The USB device is not recognized by the computer

This circumstance occasionally occurs in some OEM versions of Windows. A defect device does not necessarily cause this. In most cases updating the USB drive on the notebook or PC can solve the problem.

In case an update of the drive does not result in a satisfactory solution it is recommended to proceed as described below (the manufacturer takes no liability for any loss or damage caused by running this process!)

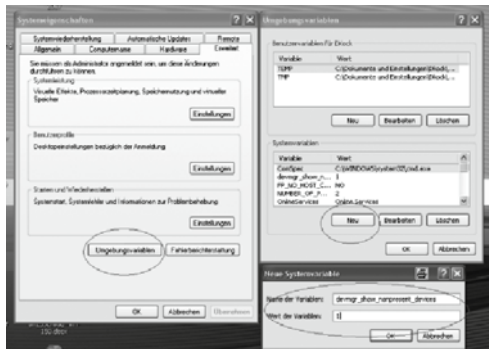

Delete the so-called 'Ghost Devices' (devices that are not currently connected to the computer). Background information: Windows generates an entry in its system preferences for each new USB device (e.g. USB stick) it is plugged into. Every time you start your computer Windows searches for these devices. This delays detection of

USB devices as well as the launch of Windows itself and is responsible for the failure to recognize the USB port!

Therefore, you should 'clear up' your system environment and remove unused devices. To do this, right-click on 'My Computer' or 'Computer' and open the 'Properties' item in the context menu. Then click in the window on the tab 'ADVANCED /ADVANCED SYSTEM SETTINGS' and click on 'ENVIRONMENT VARIABLES'. Now select the lower part (NEW ENVIRONMENT VARIABLE). At 'NAME OF VARIABLES' enter the following text:

### **devmgr\_show\_nonpresent\_devices**

Enter the value '1' in 'Value of Variables'.

Confirm the entry with 'OK' and restart the computer. After rebooting open the Device Manager. Select the menu item VIEW and activate the option 'Show Hidden Devices'. The 'Ghost Devices' previously hidden are now displayed in grey. Check for entries in the different categories such as USB, storage volumes, etc. Only delete the entries of devices you no longer use from the 'Device Manager'.

<sup>1</sup>Quelle: Microsoft Knowledge Base <http://support.microsoft.com/kb/315539/de>

## Appendix: Technical specifications

<b>Image Sensor</b>	5MP CMOS Colour
<b>Lens</b>	F/NO=3.0 FOV(Field of View)=52°
<b>PIR detection range</b>	18M/60F
<b>Display</b>	1.5" built-in LCD
<b>Memory Card*</b>	SD-card (from 8 MB to 32 GB)
<b>Image Resolution</b>	8MP = 3328×2496 Pixel 5MP = 2560×1920 Pixel
<b>Video Resolution</b>	640×480 Pixel (20fps) 1024×720 Pixel (25fps)
<b>PIR Sensor</b>	Multi Zone
<b>PIR Sensitivity</b>	Adjustable (High/Normal/Low)
<b>Trigger Time</b>	1,2s.
<b>Operation/Storage Temp.</b>	-20 - + 60° / -30 - +70°
<b>Interval</b>	1s - 60 min.
<b>Photo Burst</b>	1-3

<b>Time Lapse</b>	5 min. - 8 hrs.
<b>Video Length</b>	1s - 60s
<b>Power Supply</b>	8×AA (recommended) or 4×AA batteries*
<b>Stand-by Current</b>	< 0.25 mA (<6mAh/Day)
<b>Power Consumption</b>	400 videos (interval=5min, video length=10s); > 500 MMS (Use 8X AA batteries*)
<b>Low Battery Alert</b>	LED Indicator, Notification via E-Mail/MMS
<b>Mounting</b>	with belt
<b>Weight</b>	340 g
<b>Dimensions</b>	140×87×55 mm
<b>Operation Humidity</b>	5% - 90%

\*Not included with your purchase

## Warranty & Service

The regular guarantee period is 2 years and begins on the day of purchase. To benefit from an extended voluntary guarantee period as stated on the gift box, registration on our website is required.

You can consult the full guarantee terms as well as information on extending the guarantee period and details of our services at [www.bresser.de/warranty\\_terms](http://www.bresser.de/warranty_terms).

Would you like detailed instructions for this product in a particular language? Then visit our website via the link below (QR code) for available versions.

Alternatively you can also send an email to [manuals@bresser.de](mailto:manuals@bresser.de) or leave a message on +49 (0) 28 72 - 80 74-220\*. Please always state your name, precise address, a valid phone number and email address, as well as the article number and name.

\*Number charged at local rates in Germany (the amount you will be charged per phone call will depend on the tariff of your phone provider); calls from abroad will involve higher costs.



[www.bresser.de/3340001](http://www.bresser.de/3340001)



or visit

[www.bresser.de](http://www.bresser.de)





---

---

---

---

---

---

---

---

---

---

---

---

---

---

---

---

---

---

---

---

---

---

---

---

---

---

---

---

---

---

---

---

---

---

---

---

---

---

---

---

---

---

---

---

---

---

---

---

---

---

---

---

---

---

---

---

---

---

---

---





**Bresser GmbH**

Gutenbergstr. 2 · DE-46414 Rhede  
Germany

[www.bresser.de](http://www.bresser.de) · [service@bresser.de](mailto:service@bresser.de)