



ASTRO BASICS 1

Basic knowledge in handling telescopes

www.bresser.de

Expand your horizon

Contents

For this reading 3

Optical accessories..... 4

 Eyepiece.....4

 Zenith mirror/Zenith prism.....4

 Barlow Lens.....5

 Erecting lens.....5

Telescope systems6

 Optics/Optical tube6

 Assembly6

 Tripod6

The parallactic home position7

Astronomical coordinates8

 Alignment with the celestial pole8

 Celestial coordinates.....8

 Pitch circles10

 Setting an object using pitch circles.....10

Useful tables 11

Astronomical basics.....13

 Observation objects in space13

 The moon13

 The planets.....14

 Deep sky objects.....15

A "road map" to the stars15

"You and the universe"17

Reference stars18

For this reading

This reading matter does not replace the instruction manual for any telescope that you may have purchased! It is rather to be regarded as an accompanying source of information without any claim to completeness, with whose help you can acquire a basic astronomical knowledge. This will help you to better understand and use the many functions of your telescope.

Furthermore, if you are seriously interested in the extremely diverse hobby of "astronomy", we recommend that you deepen your knowledge even further. For this purpose, this small information brochure offers various incentives in the form of literature suggestions and links to topic-related Internet pages.

The best way to get more detailed information and to exchange ideas with like-minded people is to visit astronomy meetings and/or to become a member of an astronomical club. We also provide a list of these in this brochure.

And now have fun exploring our universe and fingers crossed for clear skies!

Your BRESSER team

Visibility conditions vary greatly from night to night and depend largely on the observation site. Air turbulence also occurs during apparently clear nights and distorts the image of objects. If an object appears blurry and poorly defined, go back to an eyepiece with a lower magnification. This will give you a sharper, better defined image (Fig. 2).

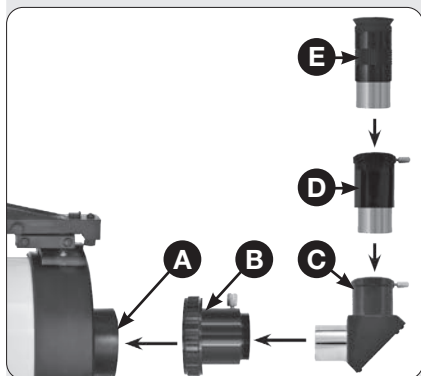

Fig. 1: Assembly sequence of optical accessories on the focusing unit (A) - here using the example of a Maksutov-Cassegrain telescope: Nut/retaining ring (B, optional), zenith prism (C), Barlow lens (D), eyepiece (E)

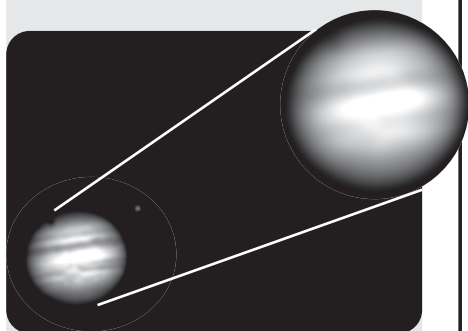

Fig. 2: The planet Jupiter. An example of correct (left) and too much magnification (right)

Optical accessories

A variety of adaptors and optical accessories are available for the different telescope types. The deeper you delve into the subject of "astronomy", the more you will learn or find out about other accessories and then perhaps also feel interested in trying them out. But we don't want to create too much confusion right away, so you should be well informed with the optical accessories listed here to get started.

Eyepiece

The main function of a telescope eyepiece is to magnify the image produced by the main optics of the telescope. Each eyepiece has a specific focal length, which is specified in millimetres (mm). The smaller the focal length, the greater the magnification. Thus, an eyepiece with a focal length of 10mm produces a higher magnification than an eyepiece with 25mm.

A distinction is made between the types SuperPlössl (SPL), Plössl (PL), Kellner (K), Super Ramsden (SR) and Huygens (H). There is no difference in the focal length itself, the differences are only expressed in the image quality and the possible applications. There are also clear differences in the size of the field of view, which is specified in degrees in addition to the type and focal length.

Very generally, one can say that eyepieces with a long focal length offer a wide field of view and provide bright and high-contrast images. This reduces eye fatigue during long periods of observation.

If you are looking for an object with a telescope, you should always start with a lower magnification eyepiece (e.g. 25mm). Then, when the object is found and is in the center of your eyepiece, you can use a higher magnification eyepiece and enlarge the image as much as the prevailing weather conditions will allow.

The magnification of a telescope is determined by the focal length of the telescope itself and the focal length of the eyepiece used. To calculate the power of the eyepiece, divide the focal length of the telescope by the focal length of the eyepiece. Here is an example using a 25 mm eyepiece.

Telescope focal length / focal length of the eyepiece = magnification of the eyepiece

Telescope focal length = 1900 mm Eyepiece focal length = 25 mm

$$\text{Magnification} = \frac{\text{Telescope's focal length}}{\text{Eyepiece's focal length}} = \frac{1900 \text{ mm}}{25 \text{ mm}} = 76$$

The magnification is therefore 76x.

Zenith mirror/Zenith prism

A Zenith mirror or Zenith prism is an additional optical component for telescopes. It is used in lens telescopes and related telescopes such as the Maksutov-Cassegrain reflecting telescope.

The Zenith prism contains a glass prism that deflects the incoming light by 90° to the eyepiece behind it. This provides a more comfortable viewing experience. A Zenith mirror works similarly, but is somewhat simple in design. Here, instead of the prism, a small flat mirror is installed.

However, the more comfortable viewing results in a side-inverted image when using a Zenith prism or mirror. This can be disturbing or irritating for certain observations.

Barlow Lens

The Barlow lens increases the telescope focal length and thus also the magnification by the specified factor (usually 3x or 2x).

A Barlow lens is inserted directly into the eyepiece holder or a zenith prism located in it. The desired eyepiece is then inserted into the Barlow lens.

Barlow lenses can in principle be used in any type of telescope.

Example of magnification calculation with Barlow lens in place:

Telescope's focal length / Focal length of the eyepiece = Magnification of the eyepiece

Telescope's focal length = 1900 mm
Focal length of the eyepiece = 25 mm
Barlow lens: 2x

$$\text{Magnification} = \frac{\text{Telescope's focal length}}{\text{Eyepiece's focal length}} \times 2 = \frac{1900 \text{ mm}}{25 \text{ mm}} \times 2 = 152$$

The magnification is therefore 152x.

Erecting Lens

The erecting lens is another useful optical accessory for refracting telescopes, which is inserted into the optical path in front of the eyepiece. It is mainly used for land/nature observation as it produces an image inversion and thus an upright image. It also usually makes it easier for astronomy beginners to find their way around the night sky, as it is not "upside down" when using an erecting lens. However, this additional lens is not suitable for reflectors (reflecting telescopes).

Reversing lenses, like Barlow lenses, increase the telescope focal length. As a rule, this is done with a factor of 2. The telescope focal length and thus the magnification is thus doubled.

ASTRO TIPS

Is it even possible to choose a magnification that is "too high"?

Yes, you can! The most common mistake made by beginners is to over-magnify the image produced by the telescope. A very high magnification is selected, which the telescope cannot provide due to its construction, weather or light conditions. Therefore, always keep in mind that a sharp but low magnification image will result (Fig. 2, lower left) is much nicer to look at than a highly magnified but completely blurred image (Fig. 2, right), which you will definitely not enjoy. Magnifications above 200x should only be selected when the air is absolutely calm and clear. Most observers should have three or four extra eyepieces on hand to take advantage of the full range of magnifications possible with the telescope.



Telescope Systems

When we speak of telescope systems here, we mean the entire construct of optics, mount and tripod that is needed in the for unrestricted observations. The individual components of this overall construct are described in more detail below. For beginners, they are usually offered in coordinated bundles. Experienced hobby astronomers not infrequently rely on the purchase of individual components and thus combine, for example, products of different brands. However, it should be noted that the interfaces must match.

We do not want to go too deep into the matter here, as it would certainly go beyond the scope. In addition, countless entries can be found on the Internet under the search terms "telescope" and "astronomy", and extensive specialist literature is also available in bookshops.

Optics / Optical tube

The optics, in combination with the receiving body also called the optic tube, is the critical component of a telescope system. It makes the observation object visible to the observer and thus allows him to experience it. There is still a misconception that high magnification is the decisive argument for good optics. However, this is simply wrong! A general statement regarding the optical quality of a telescope can never be based on this one parameter. Many different aspects play a role here.

In principle, there are only two main types of optics:

- Lens optics (also refractor or achromat) - Mirror optics (reflector or Newton)

Over the centuries, however, many designers have worked hard in pursuit of the perfect optical match. The result is a wealth of further developments, combinations of both optics variants and individual designs.

To ensure that the further explanations in this brochure are always easy to understand, we always explain facts using the example of Newtonian mirror optics.

Assembly

Besides good optics, the choice of the right assembly is important. This is the part of the telescope system on which the optics - as the name suggests - are mounted. As with the optics, there are also - you guessed it - numerous further developments in the mounts. In essence, however, these go back in origin to the following two types of mount:

- Azimuthal mount (also Alt/Az mount) - Equatorial mount (also German or parallactic mount)

We do not want to go into further detail about the different possibilities or areas of application here, but will explain various matters in more detail at the appropriate points using the equatorial mount. This type of mount is best suited for astronomical observations.

Tripod

There is an even wider choice of tripods. Because depending on the mount used and the associated connections, there are countless types of tripods. As a rule, the various manufacturers offer suitable tripods with sufficient load-bearing capacity for the mounts and optics tubes they offer. It makes sense to follow the recommendations of the manufacturers, as they can understandably only make a reliable statement about the load-bearing capacity of their tripods in conjunction with their own mounts and optics tubes. However, if you are considering combining tripods, mounts and optics tubes from different manufacturers, we strongly recommend that you contact the respective manufacturers beforehand to find out whether the desired combination is possible. Otherwise, there is a risk that the chosen construct is not stable enough and/or the individual components are not correctly connected to each other. Individual parts - especially the sensitive optics - could fall to the ground and irreparable damage would be the result.

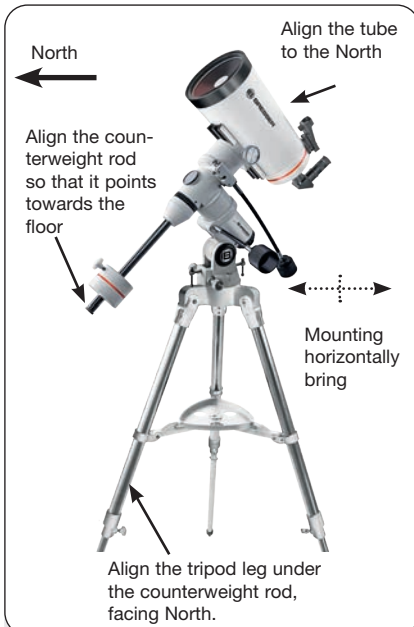

Fig. 3 The parallactic home position, side view



Fig. 4 The parallactic home position seen from the North.

The parallactic home position

For the ideal use of the telescope system or the correct alignment and the later search of objects in the night sky, the construct of optics, mount and tripod must be set in the so-called parallactic basic position. Figures 3 and 4 show this basic position. For detailed information on the exact settings of the individual telescope components, please refer to the operating manual of your telescope.

In this context, the adjustment of the latitude and the alignment of the optics to the north or to the pole star (lat. Polaris)

Once the mount has been aligned with Polaris and the latitude correctly set for your current observing location, any object in the sky can be approached and tracked.

IMPORTANT NOTE:

In the chapter "Useful tables" you will already find a comprehensive list of international capital cities. For almost all astronomical observing requirements, approximate estimates of latitude are quite acceptable. So don't let excessive attention to the exact position of the polar star take away the joy of your telescope.

ASTRO TIPS

Further studies / specialist reading

This instruction manual provides only the most important information on using the telescope. In order to make full use of the manifold possibilities of the instrument, you should definitely delve deeper into the subject of "astronomy". For this purpose, we have compiled some helpful information in an accompanying booklet, which you can download free of charge via the following weblink:

<http://www.bresser.de/download/astro-basics>

<https://www.bresser.de/c/de/support/faq/astronomie>

Furthermore, we have listed below topics that are also worth taking a closer look at. Below you will find a list of books, magazines and organizations that may be of use to you.

Topics

1. How to measure the distance of a star? What exactly is a light year?
2. How were the craters of the moon formed? How old are the earth, moon and sun?
3. What are stars made of? Why do the stars have different colours?
4. What is a "nova", a "supernova"?
5. What is meant by comets, asteroids, meteors and meteor showers?
6. Was ist ein „Planetarischer Nebel“? What is a "globular cluster"?
7. What does the term "big bang" mean? What is behind the "universe"?

Books

1. Hobby Astronomer in 4 steps (DEUTSCH/German) - OCULUM VERLAG
2. Telescope-1x1 (DEUTSCH/German) - OCULUM VERLAG
3. Cosmos Celestial Year by Hans-Ulrich Keller
4. Telescope guide in 4 steps, Oculum Verlag

Magazines

1. Astronomy - THE MAGAZINE
2. Stars and space

Organizations

1. Association of Stargazers e.V. / Germany (VdS)
2. astronomie.de , astrotreff.de

This list is only a selection and does not claim to be complete.

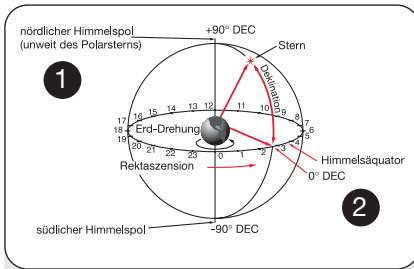

Fig. 5: The celestial spheres

Astronomical coordinates

Align to the celestial pole

When aligned to the celestial pole, the telescope is oriented so that the horizontal and vertical axes of the telescope coincide with the coordinate system in the sky (see figure).

If you want to point the MCX at the celestial pole, it is essential that you develop an understanding of how and where a cosmic object can be located as it moves through the sky. This section introduces you to the basics of astronomy and includes instructions for finding the celestial pole. In addition, you will learn about finding objects in the night sky. You will become familiar with the terms "right ascension" and "declination".

Celestial coordinates

All cosmic objects are mapped with a coordinate system on the celestial sphere (fig. 5). This celestial sphere is regarded as an imaginary sphere that surrounds the entire earth and to which all the stars seem to be attached. The celestial mapping system corresponds to the Earth-based coordinate system of longitude and latitude.

The two poles of the celestial coordinate system are defined as the two points at which the Earth's axis of rotation in its infinitely wide, fictitious extension to the north and south penetrates the celestial sphere. In this way the northern celestial pole is located (Fig. 5) exactly at the point of the sky where the extension of the earth's axis beyond the North Pole intersects the celestial sphere.

When mapping the earth's surface, the lines of longitude are drawn from the North Pole to the South Pole. Similarly, the latitudes are drawn as lines in an east-west direction, parallel to the earth equator. The celestial equator (Fig. 5) represents the projection of the earth equator to the celestial sphere.

The mapping of the celestial sphere is done in the same way as on the earth's surface: One describes imaginary lines, which together form a coordinate net. In this way, the position of an object on the earth's surface can be determined by its length and width. For example, you can determine the position of the city of Los Angeles in California by its latitude (+34°) and westerly longitude. Similarly, the constellation of the Great Bear (which contains the Big Dipper) can be determined by its general position on the celestial sphere:

$$RA = 11h; DEC = +50^\circ$$

- **Right ascension:** The heavenly equivalent of the earthly longitudes is called "right ascension" or "RA", it is given in the time scale of a 24-hour "clock". It indicates the distance measured in hours (h), minutes (m) and seconds (s) to an arbitrary "zero line" (RA 0h) passing through the constellation Pegasus. Celestial pole to the South. Celestial pole runs along the celestial sphere through the constellation of Pegasus. The coordinates of the right ascension run from 00h 00m 00s to 23h 59m 59s. In this way, there are 24 main RA lines that run vertically through the celestial equator at 15° intervals. Objects that are increasingly further east of the RA reference line (00h 00m 00s) carry increasing RA coordinate values.
- **Declination:** The celestial equivalent of the earthly latitudes is called "declination" or "DEC", it is given in degrees of an angle, minutes of arc and seconds of arc (e.g. 15°27'33"). A declination running north of the celestial equator is marked with a "+" sign in front of the corresponding angular value (the declination of the northern celestial pole, for example, is +90°). Declinations south of the celestial equator are marked with a "-" sign (the declination of the southern celestial pole is e.g. -90°). Every point that lies on the celestial equator itself - which, by the way, runs through the constellations Orion, Virgo and Aquarius - has a declination of zero - this is indicated as "00°00'00".

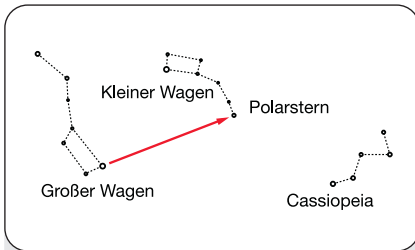

Fig. 6: Search map for the Polar Star

All objects of the sky can thus be precisely defined by their celestial coordinates in right ascension and declination.

If you want to work with the pitch circles, you need a mature observation technique. If you are using the pitch circles for the first time, try jumping from one bright star (the guiding star) to another bright star whose coordinates you know. Keep practicing by moving the telescope from one easy-to-find object to the next. In this way, you will see how important a precise approach can be in stating the setting an object exactly.

Finding the Pole Star/Celestial Pole

To get a rough idea of where the points of the compass are at an observation site, you should be aware of the directions where the sun rises (east) and sets (west) every day. After it has become dark at your place of observation, turn north - you achieve this by pointing with your left shoulder in the direction where the sun went down earlier. In order to find the pole exactly, you should now locate the polar star - use the Big Dipper as the leading star image for this purpose (Fig. 5).

For an exact tracking of astronomical objects you should align your MCX telescope to the celestial pole.

IMPORTANT NOTE:

For almost all astronomical observation projects, approximate settings of the latitude and the polar axis of the telescope are sufficient without further ado! Don't waste too much effort on aligning your telescope as perfectly as possible with the celestial pole!

Pitch circles

The telescope mount is equipped with graduated circles. These allow you to find faint cosmic objects that cannot be seen by direct visual observation. The RA pitch circle is located on the top of the drive housing of your telescope. The DEC pitch circle (19, Fig. 1d) is mounted above the counterweight rod.

If the telescope is aligned to the northern celestial pole, you should be able to read the amount 90° on the graduated circle (here, of course, $+90^\circ$ is meant!). Objects located below the 0-0 line of a DEC pitch circle have negative declination coordinates. Each graduation mark on a DEC pitch

ASTRO TIPS



Become a member of an astronomical club.

Visit a telescope meeting!

A particularly enjoyable way to get into astronomy is to join an astronomical club. Check your local newspaper, school, library or telescope dealer to see if there is a facility in your area.

At club meetings you will meet other astronomy enthusiasts with whom you can share your discoveries. The clubs offer you an excellent opportunity to get to know celestial observation better. You will learn where the best observation sites are located. You will also learn there how to compare the different references about telescopes, eyepieces, filters, tripods, and so on.

Very often you will find excellent astro photographers among the club members. Not only will you be able to see examples of their art, but you may even pick up a few useful tips from them. You could then also try these out on your Messier telescope.

Many groups also hold regular "star parties" where you can check out and use and get to know many different telescopes and other astronomical equipment. Relevant magazines announce many a popular telescope meeting in their calendar of events.

circle represents a 3.3° increment, or the numbering for each 10° . The RA sub circuit runs from 0h to 24h (the 24h are not marked!). Each graduation mark corresponds to a step of 10 min.

IMPORTANT NOTE:

The RA pitch circle has two rows of digits. So there are two series of numbers running in opposite directions around the RA pitch circle. The outer row of numbers (ascending anticlockwise) is for observers in the northern hemisphere (e.g. Europe). The inner number series (increasing clockwise) is used by observers who set up their telescope in the southern hemisphere (e.g. Australia).

Setting an object using pitch circles

First, you need to align your telescope with the celestial pole.

Find the celestial coordinates (RA and DEC) of the object in a star atlas. Loosen the RA clamp on the mount and rotate the telescope until the correct right ascension of the desired object is displayed. Tighten the RA clamp again.

Next, rotate your telescope in declination until you can read the correct declination of the object you want. If you have used this procedure carefully and your telescope is aligned sufficiently accurately with the celestial pole, then the desired object should now be visible in the field of view of the eyepiece.

If you cannot immediately see the object you are looking for, search the neighboring sky area. Keep in mind that the field of view of the telescope in conjunction with, for example, a 25mm eyepiece is only about one to three full moon diameters. Because of its much larger field of view, the viewfinder can help you greatly in locating and setting up an object once you have used the graduated circles to find the approximate position of the object.

Precise use of the graduated circles requires that you have aligned your telescope precisely with the celestial pole. Please refer to the chapter "Alignment with the celestial pole".

Useful tables

Latitude table for all major world cities

To support the procedures for "**Aligning with the celestial pole**" on page 11, the latitudes of various world cities are listed below. If you want to find the latitude of your observation site, which does not appear in this table, find a city that is close to you. Then proceed according to the following method:

Observer in the Northern Hemisphere (N):

If your observing site is further north than the city listed, add one degree of latitude for every 110km. If your observation point lies further south than the corresponding city, subtract one degree of latitude for every 110 km.

Observers in the Southern Hemisphere (S):

If your observation site is further north than the city listed, subtract one degree of latitude for every 110km. If your observation site is located further south than the corresponding city, add one degree of latitude per 110km.

EUROPE		
CITY	Country	Latitude:
Amsterdam	Netherlands	52° N
Athens	Greece	38° N
Berlin	Germany	52° N
Bern	Switzerland	47° N
Bonn	Germany	50° N
Borken/Westf.	Germany	52° N
Bremen	Germany	53° N
Dresden	Germany	51° N
Dublin	Ireland	53° N
Düsseldorf	Germany	51° N
Frankfurt/M.	Germany	50° N
Freiburg	Germany	48° N
Glasgow	Scotland	56° N
Hamburg (53.558, 9.7874)	Germany	54° N
Hanover	Germany	52° N
Helsinki	Finland	60° N
Copenhagen	Denmark	56° N
Cologne	Germany	51° N
Leipzig	Germany	51° N
Lisbon	Portugal	39° N
London	United Kingdom	51° N
Madrid	Spain	40° N
Munich	Germany	48° N
Nuremberg	Germany	50° N
Oslo	Norway	60° N
Paris	France	49° N
Rome	Italy	42° N
Saarbrücken	Germany	49° N
Stockholm	Sweden	59° N
Stuttgart	Germany	49° N
Wien	Austria	48° N
Warsaw	Poland	52° N
UNITED STATES OF AMERICA		
CITY	Country	Latitude:
Albuquerque	New Mexico	35° N
Anchorage	Alaska	61° N
Atlanta	Georgia	34° N
Boston	Massachusetts	42° N
Chicago	Illinois	42° N

USEFUL TABLES

Cleveland	Ohio	41° N
Dallas	Texas	33° N
Denver	Colorado	40° N
Detroit	Michigan	42° N
Honolulu	Hawaii	21° N
Jackson	Mississippi	32° N
Kansas City	Missouri	39° N
Las Vegas	Nevada	36° N
Little Rock	Arkansas	35° N
Los Angeles	California	34° N
Miami	Florida	26° N
Milwaukee	Wisconsin	46° N
Nashville	Tennessee	36° N
New Orleans	Louisiana	30° N
New York	New York	41° N
Oklahoma City	Oklahoma	35° N
Philadelphia	Pennsylvania	40° N
Phoenix	Arizona	33° N
Portland	Oregon	46° N
Richmond	Virginia	37° N
Salt Lake City	Utah	41° N
San Antonio	Texas	29° N
San Diego	California	33° N
San Francisco	California	38° N
Seattle	Washington	47° N
Washington	District of Columbia	39° N
Wichita	Kansas	38° N

SOUTH AMERICA

CITY	Country	Latitude:
Asuncion	Paraguay	25° S
Brasilia	Brazil	24° S
Buenos Aires	Argentina	35° S
Montevideo	Uruguay	35° S
Santiago	Chile	34° S

ASIA

CITY	Country	Latitude:
Beijing	China	40° N
Seoul	South Korea	37° N
Taipei	Taiwan	25° N
Tokyo	Japan	36° N
Victoria	Hong Kong	23° N

AFRICA

CITY	Country	Latitude:
Cairo	Egypt	30° N
Cape Town	South Africa	34° S
Rabat	Morocco	34° N
Tunis	Tunisia	37° N
Windhoek	Namibia	23° S

Astronomical basics

At the beginning of the 17th century In the mid-nineteenth century, the Italian scientist Galileo Galilei took a primitive telescope, considerably smaller than your Messier telescope, and instead of pointing it at distant trees and mountains, started looking at the sky. What he saw there and what he concluded from his observations changed man's worldview forever. Try to imagine how it feels to be the first person to see the moons orbiting Jupiter or to follow the changing phases of Venus! Based on his observations, Galileo correctly concluded that the earth revolves around the sun. He thus set modern astronomy on its way. Nevertheless, Galileo's telescope was so bad that he could not even see Saturn's rings correctly.

Galileo's discoveries laid the foundation for understanding the motion and nature of planets, stars, and galaxies. Henrietta Leavitt drew on these basics and figured out how to measure the distance to the stars. Edwin Hubble ventured into the origins of the universe. Albert Einstein revealed the relationship between time and light. Almost every day today, little by little, the mysteries of the universe are solved and deciphered. The most advanced successors to the primitive Galilean telescope are used, including the Hubble Space Telescope. We get to live in the "golden age of astronomy"!

In contrast to other natural sciences, astronomy also welcomes contributions from amateurs. Many of the insights we have gained into comets, meteor showers, variable stars, the Moon, and our solar system originally came from observations by amateur astronomers. So when you look through your Messier telescope, you bring back the memory of Galileo. For him, the telescope was not just a simple apparatus made of glass and metal, but much, much more: A window through which you can experience the beating heart of the universe for yourself.

Observation objects in space

Below are a few of the countless astronomical objects that can be viewed with the Messier telescope.

The moon

The moon is on average 380,000km away from the earth. It can be observed most beautifully whenever it appears as a crescent or half moon. This is because the sunlight hits its surface at a flat angle and creates long shadows, giving it a truly three-dimensional appearance (Fig. 42) During the full moon phase no shadows are visible on the surface, therefore the now extremely bright moon appears flat and uninteresting in the telescope. When observing the moon it is often advisable to use a neutral moon filter. On the one hand this protects your eye from the glare of the moon and on the other hand it helps to increase the contrast.

In the Messier telescope, you can admire glorious details on the Moon; there are hundreds of lunar craters and lunar seas, so-called, as described below. "Maria."

The craters are circular meteor crash sites. They cover almost the entire lunar surface. There is neither an atmosphere on the moon, nor do any weather phenomena take place - only the meteor crashes cause some erosion. Under these conditions, lunar craters can last for many millions of years.

The "maria" (plural of "mare") or "lunar seas" appear as smooth, dark zones extending across the lunar surface. These dark areas are thought to be extensive basin landscapes formed long ago by crashes of meteors or comets. As a consequence they were later filled up with molten lava from the interior of the moon.

Twelve Apollo astronauts left their boot prints on the moon in the late sixties and early seventies. However, there is not a single telescope on earth that could show these footprints or any other relics. The smallest lunar details that can just be detected with the largest telescope on Earth have a diameter of about 800m at best.

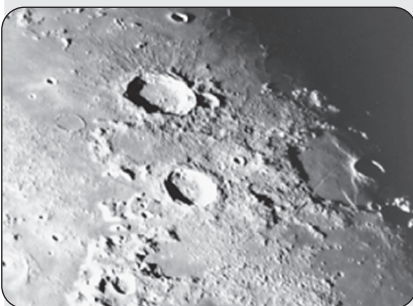

Fig. 42: The moon Note the shadows in the craters.



Fig. 43: The planet Jupiter with its moons, shown here with a small magnification.

The planets

On their way around the sun, the planets constantly change their position in the sky. Consult a monthly astro magazine (Interstellarum, Astronomy Today, Stars and Space) to find planets in the sky or search the Internet. In the following you will find a list of the planets which are particularly suitable for observation with the Messier telescope:

Venus: The diameter of Venus is about nine tenths of the diameter of the earth. While Venus orbits around the Sun, the observer can follow how it constantly changes its light phases: Sickle, half Venus, full Venus - very similar to what you are used to from the moon. The planet disk of Venus appears white, because the sunlight is reflected by a compact cloud cover that covers all surface details.

Mars: The diameter of Mars is about half the diameter of the earth. Mars appears in a telescope as a tiny, reddish-orange slice. There's a chance you might spot a touch of white when you look at one of the planet's two icy polar caps. Approximately every two years, additional details and colour effects become visible on the planet's surface. This happens whenever Mars and Earth come closest to each other on their orbits.

Jupiter: The largest planet in our solar system is called Jupiter, its diameter is eleven times larger than the Earth. The planet appears as a disk over which dark lines extend. These lines are cloud bands in the atmosphere. Even at the lowest magnification, four of the 18 Jupiter moons (Io, Europa, Ganymed and Callisto) can be recognised as "star-shaped" light points. 43 Because these moons orbit Jupiter, the number of visible moons may change over time.

Saturn has nine times the earth diameter and appears as a small, round disc. Its rings protrude from both sides of this disc. 44, 44a). Galilei, who in 1610 was the first man to observe Saturn in a telescope, could not have foreseen that what he saw would be rings. He thought Saturn had "ears." Saturn's rings consist of billions of ice particles, their size probably ranging from the tiniest dust particle to the size of a dwelling house. The largest ring division within Saturn's rings, the so-called "Cassini division", can normally be seen in the telescope. Titan, the largest of Saturn's 22 moons, is also visible as a bright, star-shaped object not far from the planet.

Under good visibility conditions, up to 6 Saturn moons can be observed in the telescope.

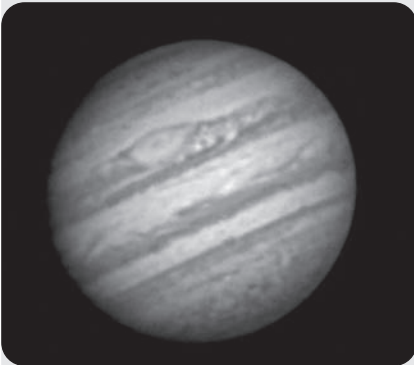

Fig. 43a: The planet Jupiter, shown here with a high magnification. The cloud structures are clearly visible. The four big moons can be observed in a different position every night.

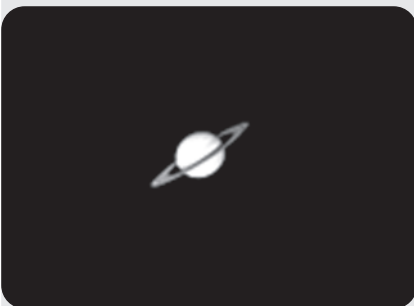

Fig. 44: The planet Saturn with its rings, shown here with a small magnification.



Fig. 44a: The planet Saturn, now shown here with a higher magnification. The ring divisions are clearly visible. Saturn has the largest rings in the solar system.



Fig. 45: A favorite winter object - the large Orion Nebula M42 in the constellation Orion.

You can hardly imagine the distances? Then take a look at [page 17](#).



Fig. 46: The open star cluster of the Pleiades (M45) seen with a wide-angle eyepiece. They belong to the most beautiful open star clusters.

Deep sky objects

In order to find constellations, single stars or "deep sky objects", the use of a star chart is recommended. In the following, various examples of deep sky objects are listed:

The stars are huge gaseous objects that glow independently because they generate energy in their centre through nuclear fusion. Due to their enormous distance, all stars appear as needle-sharp points of light, regardless of the size of the telescope used.

The nebulae are extended interstellar gas clouds and dust clouds from which new stars are formed. The most impressive nebula is without question the Great Orion Nebula (M42, Fig. 45), a diffuse nebula that looks like a faint, fibrous, grey cloud. M42 is 1600 light-years away from Earth.

An open star cluster consists of a loose group of younger stars, all of which have only recently emerged from a single diffuse nebula. The Pleiades (Fig. 46) form an open star cluster at a distance of 410 light years. Several hundred stars can be observed in the telescope.

Constellations are two-dimensional, imaginary star patterns which ancient civilizations believed to be heavenly equivalents of objects, animals, humans or gods. These groups of stars are far too large to be seen in their entirety in a telescope. If you want to learn the constellations, start with a distinctive group of stars - for example, the Great Dipper in the constellation of the Great Bear. You will then use a star chart to help you decipher the other constellations.

The galaxies are gigantic clusters of stars, nebulae, and star clusters, all held together by their mutual gravity. They are mostly spirally shaped (this also applies to our Milky Way), but many galaxies can also look like elliptical or irregular light spots. The Andromeda Galaxy (M31, Fig. 47) is the closest spiral galaxy to us. The sight of this Milky Way system resembles that of a blurred fog spindle. At a distance of 2.2 million light years they are found in the constellation Andromeda. It stands halfway between the big "W" of Cassiopeia and the star square of Pegasus.

A "road map" to the stars

The night sky is full of wonder and mystery. You too are free to enjoy exploring the universe. You just need to follow some guide lines on the "road map" to the stars.

First of all, locate the Big Dipper, which is considered part of the Big Dipper constellation. The Big Dipper is usually quite easy to find in North America or Europe throughout the year.

If you draw a line in the sky that is extended far out "backwards" from the body of the waggon, you will eventually come to the constellation Orion. Orion stands out especially because of the "Orion Belt", a string of three stars. The Orion Nebula is located south of this belt and is one of the most observed deep sky objects in amateur astronomy.

Starting from the two "pointer stars" - the two rear stars of the car body - pull a fivefold extension up to the polar star. If you extend this line far beyond Polaris, you will reach the large square of stars shared by Pegasus and Andromeda.

The summer triangle is a striking sky region to the left of the Big Dipper drawbar. This triangle consists of three very bright stars: Vega, Deneb and Atair.

If you draw an imaginary line straight towards the car drawbar, you will come to the summer constellation of Scorpio. The scorpion bends in the sky like a scorpion tail to the left, it also looks a little like the letter "J".

The American amateurs coined the saying "Arc to Arcturus and spike to Spica", in German as much as "Bogen zum Arkturus und Spitze zur Spika". They thus refer to a region of the sky which lies in the direct exten-



Fig. 47: The Andromeda Galaxy, the largest in our vicinity.

Messier tips

Star charts

Star atlases and rotating star maps are extremely useful and helpful utensils when it comes to planning an observation night.

There are a large number of star atlases in book form, in magazines, on the Internet and on CD-ROM. The Messier telescopes come with the star chart software "Cartes du Ciel" as standard.

sion of the arc which is described by the drawbar of the Great Dipper. Follow the arc to Arkturus, the brightest star in the northern hemisphere, and then "point" down to Spica, the 16th brightest star in the sky.

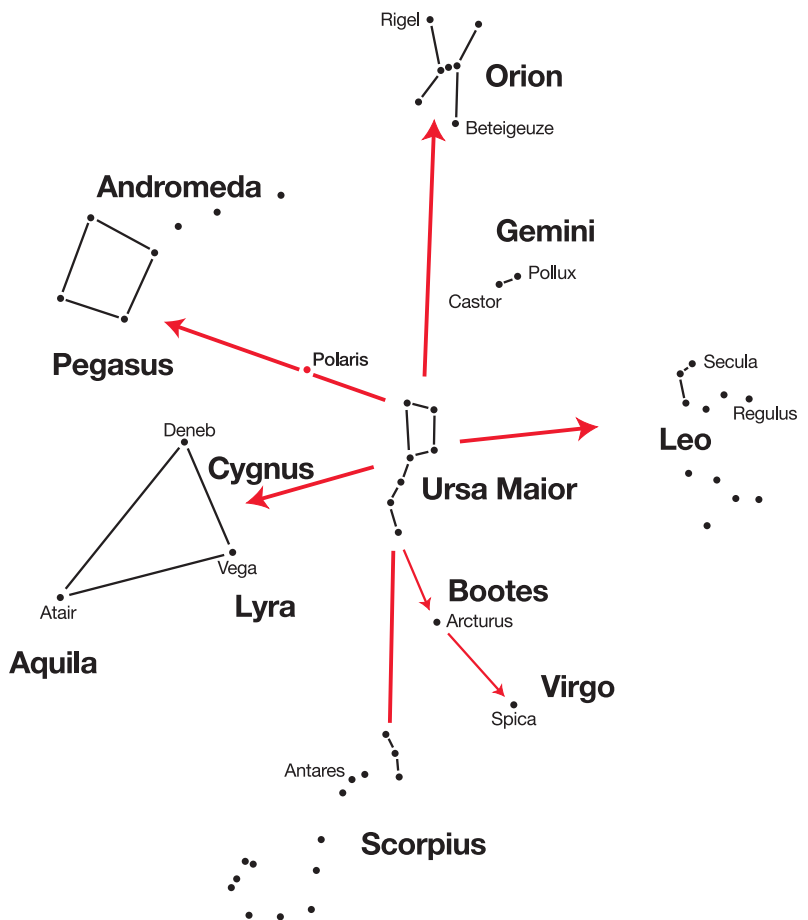
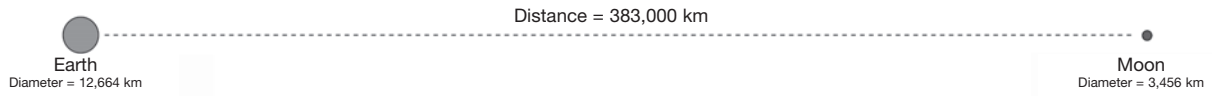

Fig. 48: Simple star chart

"You and the universe"

The distance between Earth and Moon



The distance between the planets

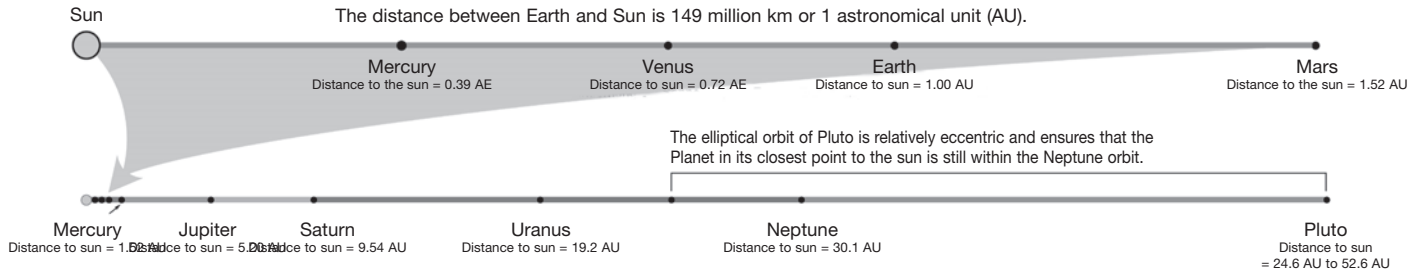

The distance between the stars

The distance from the sun to the nearest star is about 4.3 light years or about 40 trillion km. This distance is so great that in a model where the Earth would be 25 mm away from the Sun, the distance to the nearest star would be over 6.5 km!

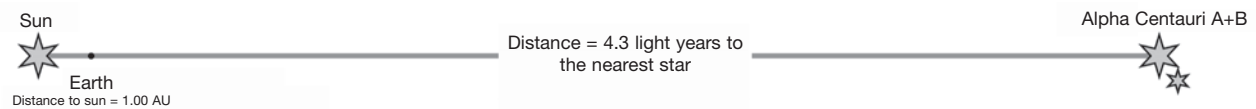

Our home galaxy, the Milky Way, together with our Sun, contains nearly 100 billion stars. It represents a spiral-shaped cluster of stars, presumably more than 100,000 light years in diameter.

The distance between the galaxies

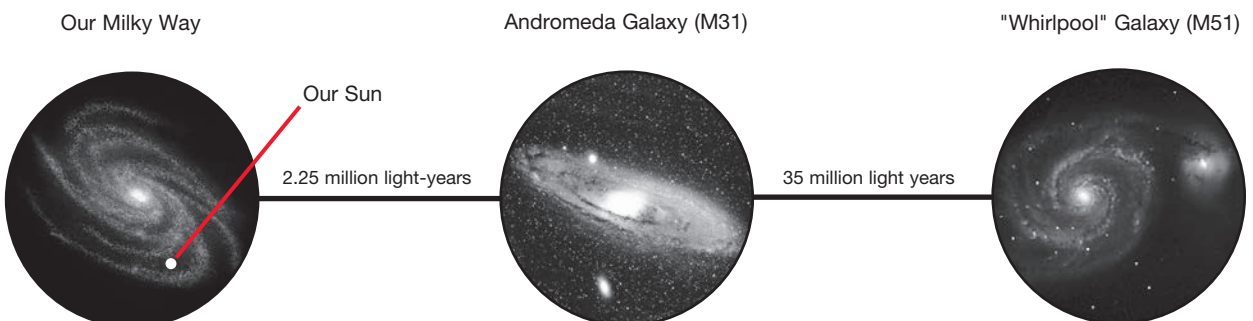

Fig. 49: Distances in the universe

Winter

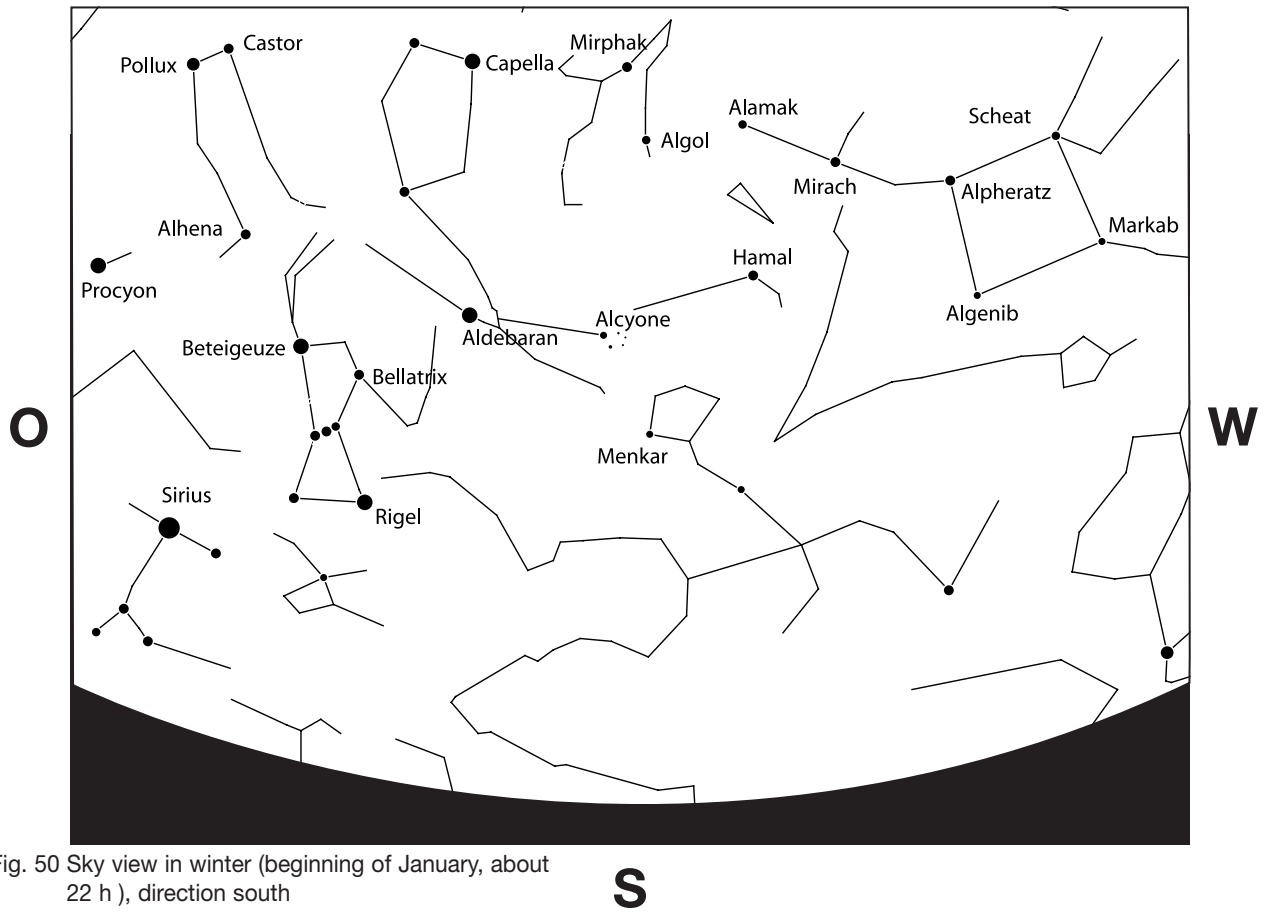

Fig. 50 Sky view in winter (beginning of January, about 22 h), direction south

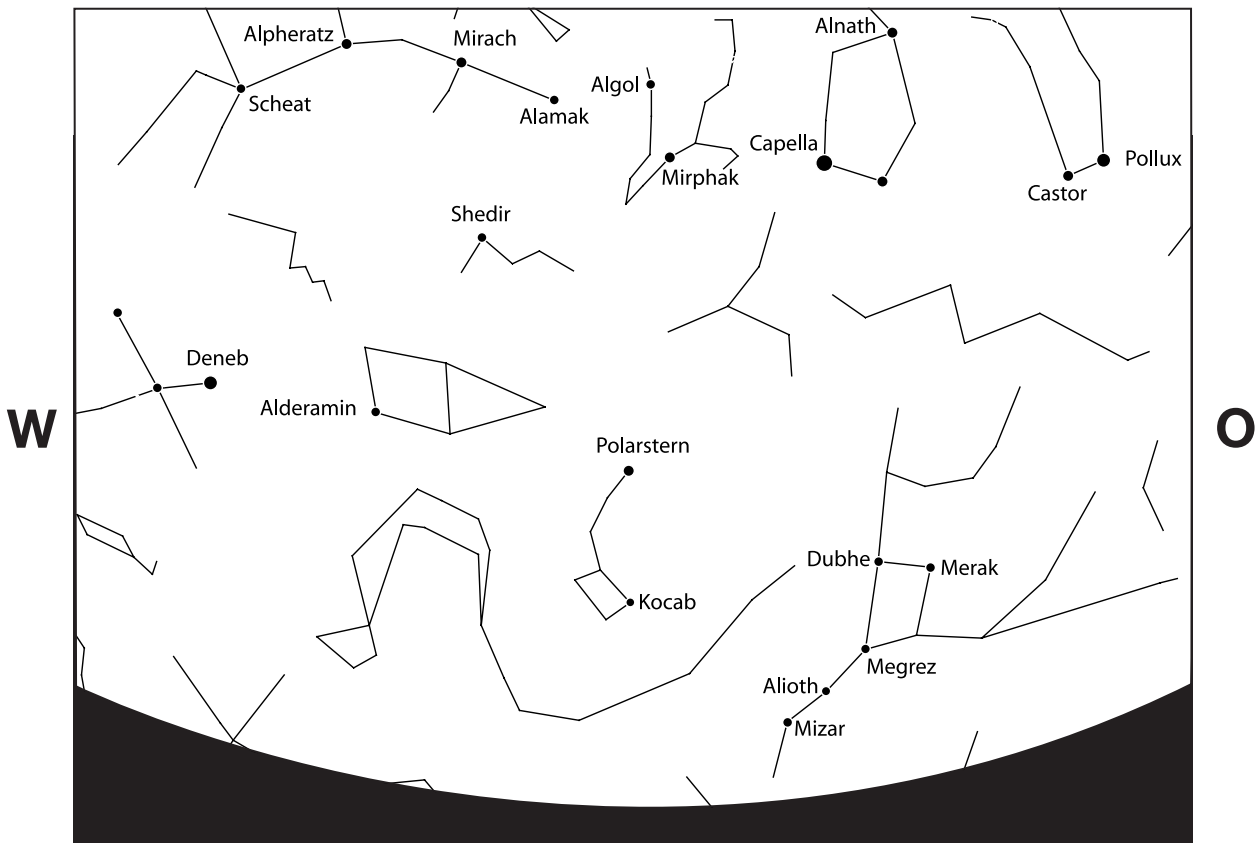

Fig. 50a: Sky view in winter (beginning of January, about 22 h), direction north

Spring



Fig. 51: Sky view in spring (beginning of April, approx. 22 h), direction south

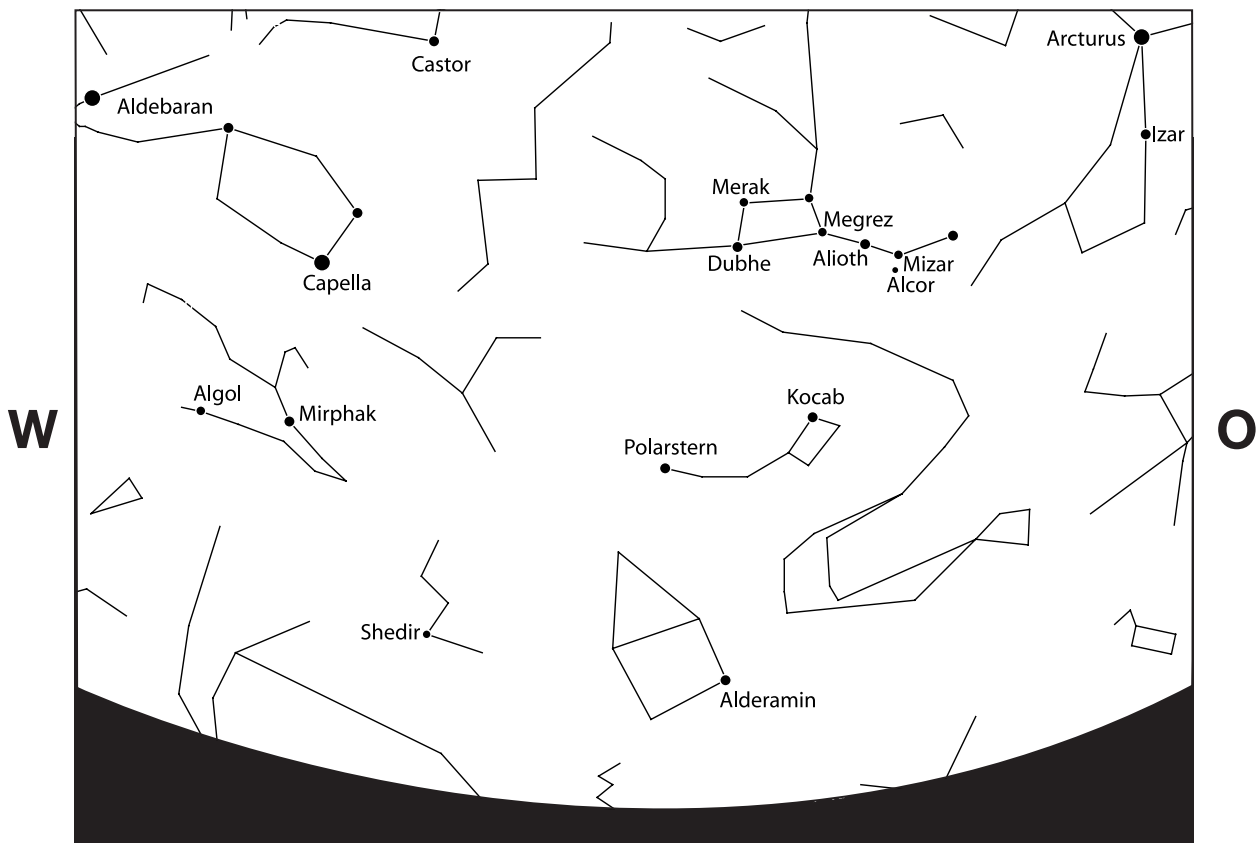

Fig. 51a: Sky view in spring (beginning of April, about 22 h), direction north

Summer

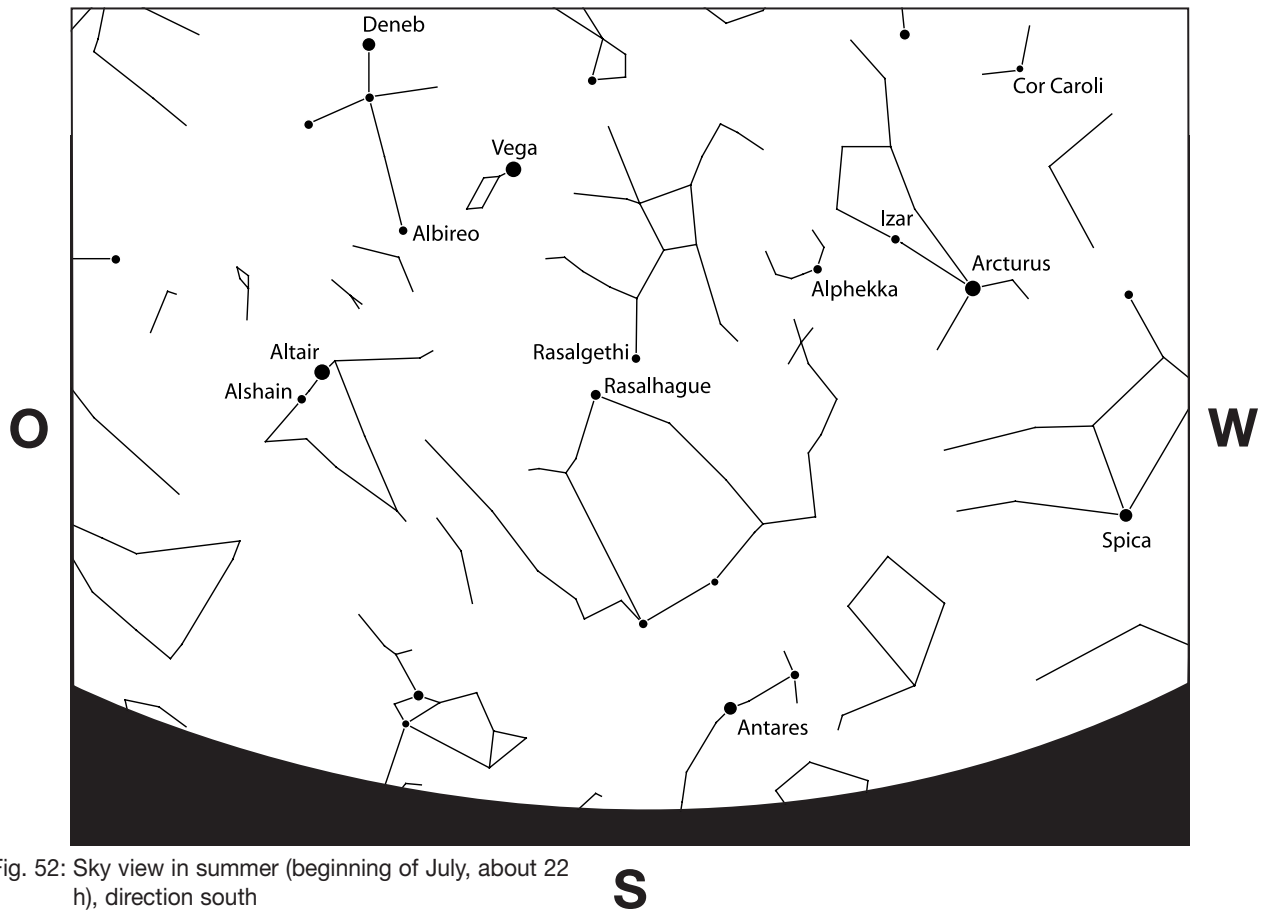

Fig. 52: Sky view in summer (beginning of July, about 22 h), direction south

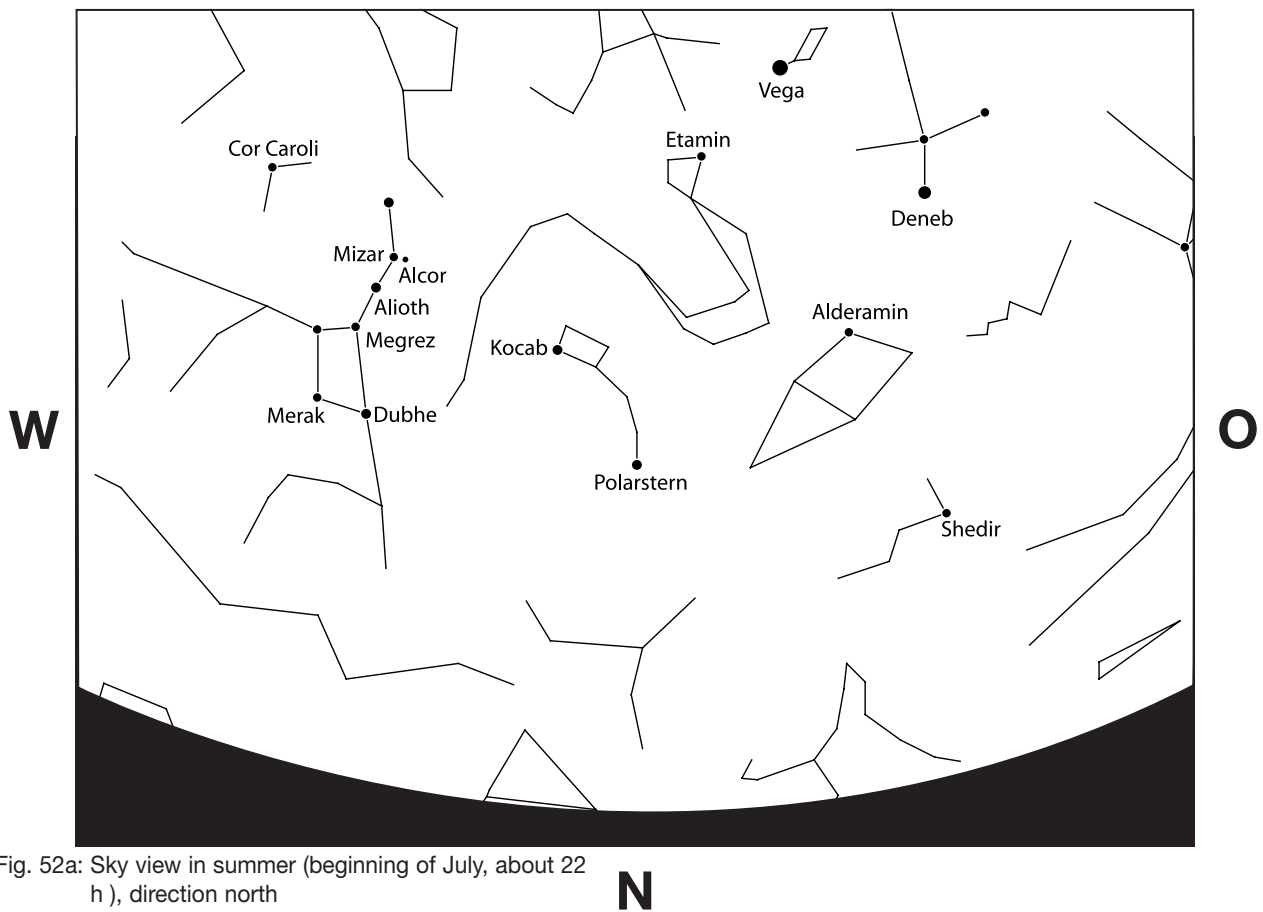

Fig. 52a: Sky view in summer (beginning of July, about 22 h), direction north

Fall

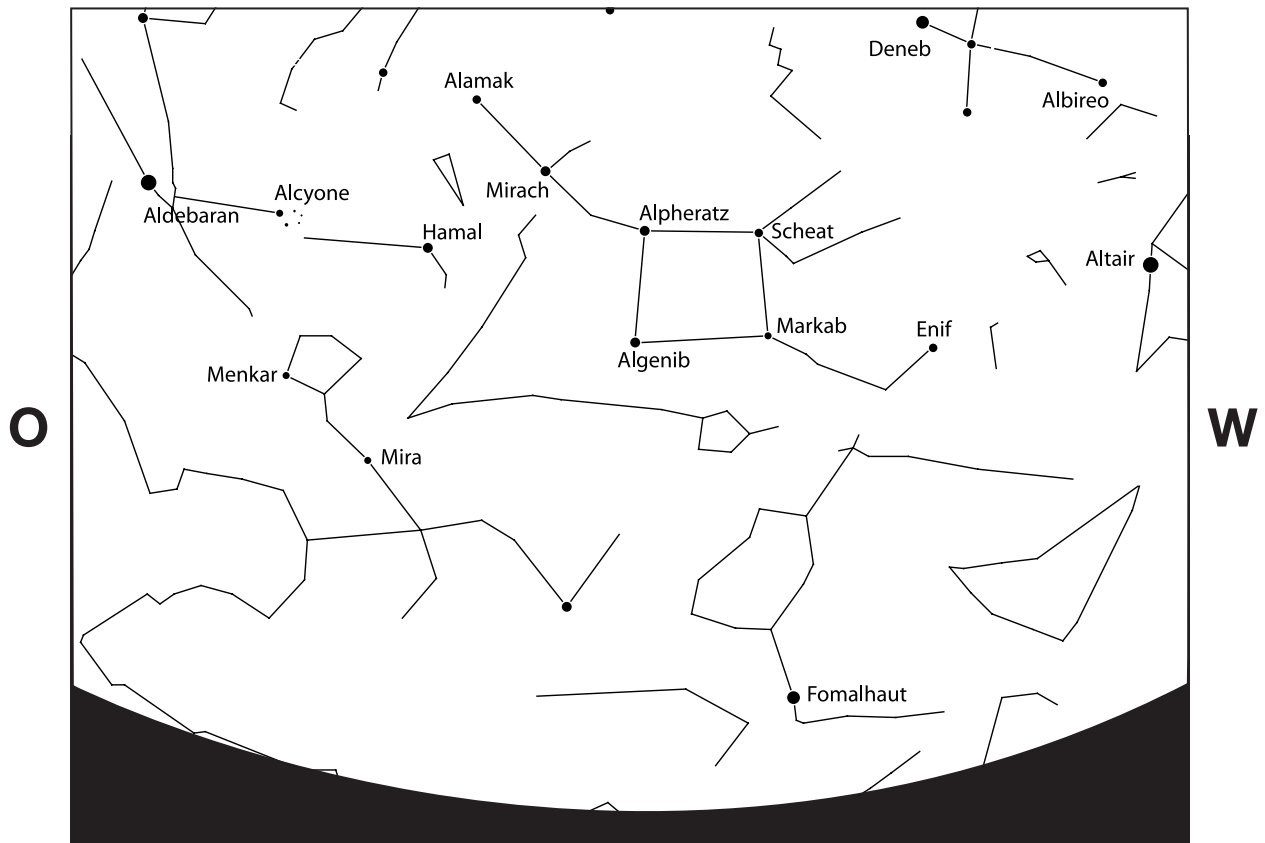

Fig. 53: Sky view in autumn (beginning of October, about 22 h), direction south

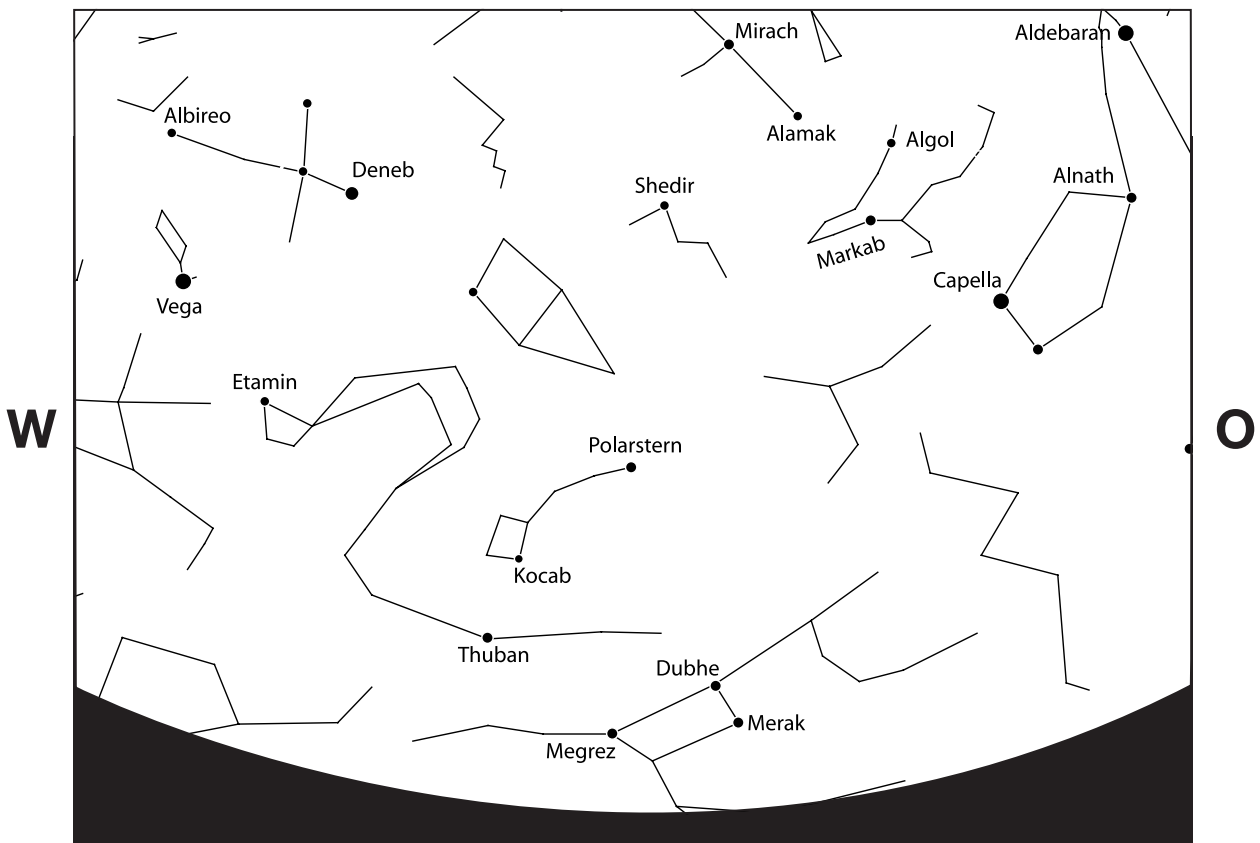

Fig. 53a: Sky view in autumn (beginning of October, about 22 h), direction north

Bresser GmbH
Gutenbergstraße 2
46414 Rhede · Germany
www.bresser.de

    @BresserEurope



© 2022 Bresser GmbH, 46414 Rhede, Germany.
No part of this manual may be reproduced, transmitted, transcribed or translated into any language in any form without the written permission of Bresser GmbH.
Errors and omissions excepted. / Cover picture: storyblocks.com
Info_Astro-Knowledge-1-Basics_en_BRESSER_v032022a