



WEATHER CENTER



GB IE

Instruction Manual

General Information

About this Instruction Manual

Please read the safety instructions in this manual carefully. To avoid damage to the unit and the risk of injury, only use this product as described in the manual.

Keep the instruction manual handy so that you can easily look up information on all the functions.



DANGER!

You will find this symbol in front of every section of text which deals with the risk of severe injury or even death in the event of improper use.



CAREFUL!

You will find this symbol before every section of text that deals with the risk of minor to severe injuries resulting from improper use.



NOTE!

You will find this symbol in front of every section of text which deals with the risk of damage to property or the environment.

Intended Use

This product is intended only for private use. It was developed as an electronic medium for the use of multimedia services.

General Warning



DANGER!

This device contains electronic components which operate via a power source (power supply and/or batteries). Do not leave children unattended when using the device. Only use the device as described in the manual, otherwise you run the **RISK** of an **ELECTRIC SHOCK**.

Children should only use the device under adult supervision. Keep packaging material (plastic bags, rubber bands, etc.) out of the reach of children! There is a **RISK OF CHOKING!**

Keep batteries out of the reach of children! Make sure you insert the batteries correctly. Empty or damaged batteries could cause burns if they come into contact with the skin. If necessary, wear adequate gloves for protection.



DANGER!

Do not expose the device to high temperatures. Use only the recommended batteries. Do not short circuit the device or batteries, or throw them into a fire. Excessive heat or improper handling could trigger a short circuit, fires or even explosions!

! NOTE!

Do not disassemble the device. In the event of a defect, please contact your dealer. He will contact the Service Centre and can send the device in to be repaired, if necessary.

Use only the recommended batteries. Always replace weak or empty batteries with a new, complete set of batteries at full capacity. Do not use batteries from different brands or with different capacities. The batteries should be removed from the unit if it has not been used for a long time.

Notes on cleaning



Separate the device from the power supply before cleaning (remove batteries)!

! NOTE!

Only use a dry cloth to clean the exterior of the device. Do not use any cleaning fluid to avoid damaging the electronics.

Disposal

 Entsorgen Sie die Verpackungsmaterialien sortenrein. Informationen zur ordnungsgemäßen Entsorgung erhalten Sie beim kommunalen Entsorgungsdienstleister oder Umweltamt.

 Dispose of the packaging materials properly, according to their type (paper, cardboard, etc).
 Contact your local waste disposal service or environmental authority for information on the proper disposal.

Do not dispose of electronic devices in the household garbage!
 As per the Directive 2002/96/EC of the European Parliament on waste electrical and electronic equipment and its adaptation into German law, used electronic devices must be collected separately and recycled in an environmentally friendly manner.

In accordance with the regulations concerning batteries and rechargeable batteries, disposing of them in the normal household waste is explicitly forbidden. Please pay attention to dispose of your used batteries as required by law - at a local collection point or in the retail market (a disposal in domestic waste violates the Battery Directive).

Batteries that contain toxins are marked with a sign and a chemical symbol. „Cd“ = cadmium, „Hg“ = mercury, „Pb“ = lead.



Cd¹



Hg²



Pb³

¹ battery contains cadmium

² battery contains mercury

³ battery contains lead

Introduction

Congratulations on your purchase of the BRESSER Weather Center. The weather center consists of a main console unit with a remote control, as well as an assortment of remote sensors which collect and transmit a wide range of weather data, including outdoor temperature, humidity, wind speed and direction, rain amount and rain rate.

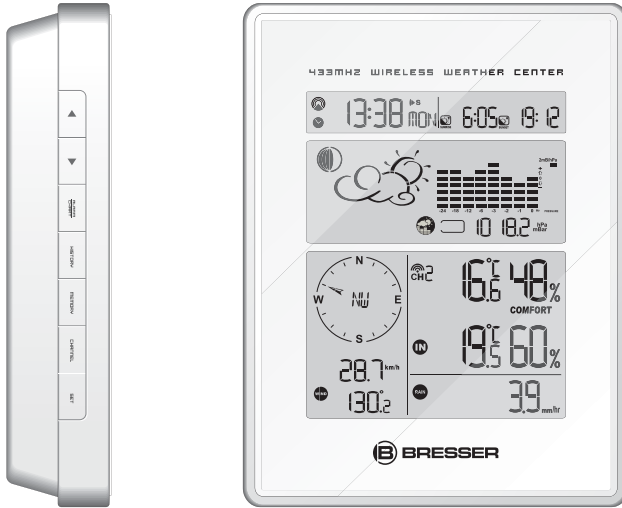

Main Console Unit

The main console unit features a radio-controlled atomic precision clock with alarm and weather forecast. It measures indoor temperature and humidity, and displays weather data collected by the remote weather sensors. It also provides indication of the indoor/outdoor temperature, pressure and humidity trends, and celestial information such as moon phase, and sunrise/set times.

Bresser GmbH
DE-46414 Rhede/Westf. · Germany



Remote Weather Sensors

The remote weather sensors include a thermo-hygrometer, anemometer (wind sensor) and rain sensor. All data collected by the sensors are transmitted to the main console unit by wireless RF, with a range up to 100 meters (open area). The weather center supports a maximum of 5 thermo-hygrometers, allowing 5 channels of temperature/humidity display.



Thermo-Hygro-Sensor



Rain sensor

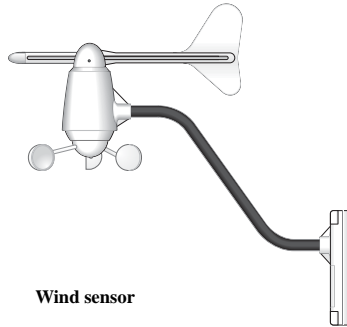

Wind sensor

Features

Weather Forecast

- Sunny, Partly Cloudy, Cloudy, Slight Rain, Heavy Rain, Snow and Unstable Weather Conditions

Pressure

- Current or historical pressure (mbar/ hPa, mmHg or inHg)
- Altitude or sea-level pressure adjustment for atmospheric pressure compensation
- Pressure trend indication
- Sea-level pressure history for the last 24 days
- Sea-level pressure history bar chart

Moon Phase

- 12 steps of moon symbols
- Scans moon phase for year 2000 to 2099
- Moon phase history for the last or future 39 days

Radio Controlled Clock

- Time and date synchronized by radio signal DCF-77 to atomic clock precision (time and date also manually adjustable)

Clock and Calendar (12 hr/ 24 hr) (month/day or day/month)

- Different combinations of clock and calendar displays
- 6 languages for day of week (English/ German/ French/ Italian/ Spanish/ Dutch)

Alarms

- Single alarm: activated once at specified time
- Weekday alarm: activated everyday from Monday to Friday at specified time
- Pre-alarm: activated ahead of single or weekday alarm if channel 1 temperature falling to +2°C or below (fixed 30 minutes)
- Programmable snooze function (1-15 minutes)

Sunrise Time and Sunset Time

- Calculates sunrise/set times with geographical information provided by user (DST, zone time offset, latitude, longitude)
- Over 133 preset cities can be selected for automatic geographical information input

Remote Temperate and Relative Humidity, with Trend Indication

- Indoor and outdoor temperature and relative humidity display (°C or °F)
- Temperature and relative humidity trend indication
- Dew point display
- Max and Min memory for temperature and relative humidity

Comfort Level Indicator

- Analyzes current environmental conditions (Comfort, Wet and Dry)

Rainfall Measurement



- Records rainfall amount for the last hour, last 24 hours, last day, last week and last month (inch or mm)
- Daily rainfall alert if rainfall for the current day exceed pre-specified amount.

Wind

- Temperature at place of anemometer
- Temperature (°C or °F) adjusted to wind chill factor
- Wind direction compass display. Wind direction angles available as compass points or bearings
- Average wind speed and gust speed (mph, m/s, knots, and km/h)
- Daily Maximum wind speed and gust speed memory.
- Wind speed alert for average wind speed and wind gust speed

Contents of Complete Weather Center Kit

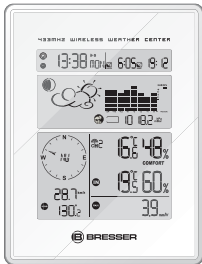
Before installing your weather center, please check that the following are complete:

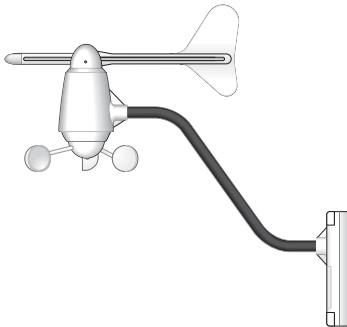
	Hardware Components	Fittings
	Main Console Unit	
	Thermo-Hygro Sensor	
	Rain Sensor: - Funnel shaped lid with battery hatch - Sensor base - Bucket see-saw mechanism - Protective screen	4 screws for securing unit to ground
	Anemometer (Wind Sensor): - Wind cups - Wind vane - Anemometer arm - Anemometer base	4 screws for securing unit to vertical surface

Installing your Weather Center

Setting up the Remote Weather Sensors

Before starting up the main console unit, setup all the remote sensors first.

When placing the sensors, make sure that they are within receiving range of the console unit. Ideally, they should be within the line of sight of the console unit. Transmission range may be affected by trees, metal structures and electronic appliances. Test reception before permanently mounting your weather center.

Also make sure that the sensors are easily accessible for cleaning and maintenance. The remote sensors should be cleaned on a weekly basis, since dirt and debris will affect sensor accuracy.

Setting up the Thermo-Hygro Sensor(s)

1. Open the latch at the base of the thermo-hygro sensor.
2. Set the channel with a slide switch.
3. Insert two 2 x UM-3 or “AA” size 1.5 V batteries.
4. Use a pin to press the “RESET” key which is in the battery compartment of thermo-hygro sensors after LED flash.
5. Replace the latch and mount the unit at desired location.

Placement Tips:

- The thermo-hygro sensor should be in an area with free air circulation and sheltered from direct sunlight and other extreme weather conditions. Place the unit in a shaded area, such as under a roof.
- Avoid placing the sensor near sources of heat such as chimneys.
- Avoid any areas which collect and radiate heat in the sun, such as metal, brick or concrete structures, paving, patios and decks.
- Ideally, place the sensor above natural surfaces such as a grassy lawn.
- The international standard height for measurements of air temperature is at 1.25m (4 ft) above ground level.

Setting up the Rain Sensor

1. Unlock the funnel-shaped top of the rain sensor by turning both knobs on the sides of the rain sensor in an anti-clockwise direction.
2. Lift the top off the base and insert two 2 x UM-3 or “AA” size 1.5 V batteries into the battery holder.
3. Replace the lid and secure into place by turning the knobs clockwise.
4. Place the rain sensor in a location such that precipitation can fall directly into the sensor, ideally 2-3 ft above the ground.
It may be secured into place by using the four screws provided.
5. The sensor must be accurately leveled for optimum performance. To check if the sensor is leveled, remove the lid and check if the ball bearing inside is at the midpoint of the leveler. Additionally, a bubble level or carpenter’s level may be used.
6. Attach the protective screen onto the top of the lid. The screen will prevent any debris entering the sensor.

Placement Tips:

- The rain sensor should be placed in an open area away from walls, fences, trees and other coverings which may either reduce the amount of rainfall into the sensor, deflect the entry of wind-blown rain, or create extra precipitation runoff. Trees and rooftops may also be sources of pollen and debris.
- To avoid rain shadow effects, place the sensor at a horizontal distance corresponding to two to four times the height of any nearby obstruction.
- It is important that rain excess can flow freely away from the sensor. Make sure that water does not collect at the base of the unit.
- The rainfall measurement mechanism utilizes a magnet, hence do not place any magnetic objects around the proximity of the sensor.

Setting up the Anemometer (Wind Sensor)

1. Assemble the wind cups and wind vane to the anemometer arm
2. Attach the assembled anemometer to the base.
3. Insert two 2 x UM-3 or “AA” size 1.5 V batteries into the battery holder in the base.
4. Mount the anemometer onto a vertical surface, using the fittings provided.
5. To allow the main console unit to find the direction which the wind vane is oriented, the following procedures are required:
 - i. Insert the batteries
 - ii. Point the wind vane towards the north. Use a compass or map if necessary.
 - iii. Use a pin to press the “SET” key which is in the battery compartment of the wind sensor.

Note: Above procedure must be repeated for changing battery.

The “SET” will toggle the direction between two modes:

1. Let the wind direction as manufacturer has designed. It will be as a default setting after changing the batteries.
2. Set the current direction as NORTH.

Placement Tips:

- Check that wind can travel freely around the anemometer and is not distorted by nearby buildings, trees or other structures.
- For better results, place the anemometer at least 3m above local structures and obstacles. The ground creates a frictional effect to wind flow and will attenuate readings.
- Aim for maximum exposure of the anemometer to the commonest wind directions in your area.
- The official mounting location for anemometers is 10m (33 ft) above ground level in a clear unobstructed location.

Setting up the Main Console Unit

1. Open the latch at the back of the main console unit.
2. Insert 4 x UM-3 or “AA” size 1.5 V batteries according to the polarities shown.
3. Reattach the latch.
4. If placing the console unit on a table or horizontal surface, fold out the table stand and adjust to the optimal viewing angle.
5. If mounting the console unit on a wall or vertical surface, fold the table stand back into the unit and use the fitting provided.

Placement Tips:

Make sure that the console unit is within the receiving range of all remote sensors. Ideally sensors should be within the line of sight of the console unit. Transmission range may be affected by trees, metal structures and electronic appliances. Test reception before permanently mounting your weather center.

The console unit measures indoor temperature, humidity, pressure and receives signals from all remote sensors and radio-clock broadcasts. Avoid placing the console unit in the following areas:

- Direct sunlight and surfaces which radiate and emit heat.
- Near heating and ventilation devices, such as heating ducts or air conditioners.
- Areas with interference from wireless devices (such as cordless phones, radio headsets, baby listening devices) and electronic appliances.

Starting up the Main Console Unit

Once the console unit is properly powered, the display will start showing some data and weather parameters. Wait for a few minutes for the console to finish self-calibration and for the sensor readings to show up.

If “---” is still displayed for the sensor reading(s), check the wireless transmission path and the batteries for the corresponding sensor.

Using your Weather Center

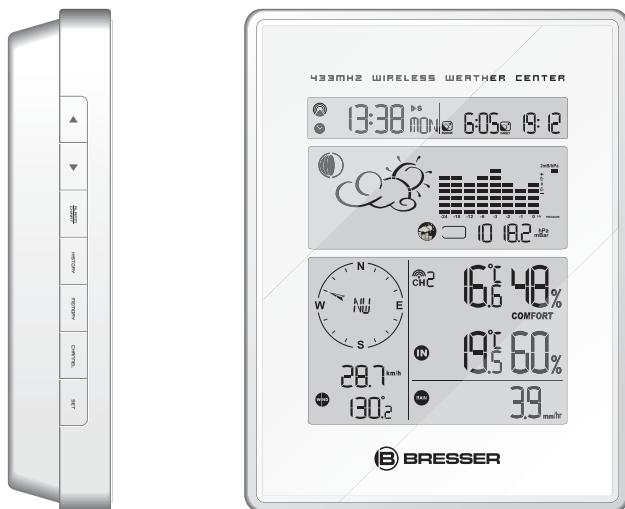

Buttons and Controls

The following controls are available on the main console unit:

- ▲ UP**
 - Switches to next mode in anti-clockwise direction
 - Increment for setting parameters
- ▼ DOWN**
 - Switches to next mode in clockwise direction
 - Decrement for setting parameters
- SET**
 - Rotates display for current mode
 - Press and hold to enter setup or change units
 - Confirmation for setting parameters
- MEMORY**
 - Shows records for moon phase, UV, temperature, humidity, rain and wind
- HISTORY**
 - Shows history for sea-level pressure
- ALARM/CHART**
 - Shows time alarms and alerts for temperature, rain and wind
 - Press and hold to enter alarm/alert setup
 - Press and hold in Pressure and Weather Forecast Mode to view different bar-charts
- CHANNEL**
 - Changes temperature and humidity display to selected channel
 - Press and hold to enable cycling display of channel temperature and humidity
- SNOOZE**
 - Enters Snooze mode when alarm is activated

Navigating between Different Modes

There are 7 modes available on the main console unit, and each one displays a different category of data. When display is in a certain mode, its corresponding icon will start flashing.

To navigate between the different modes from the main console unit, press **UP** to cycle through the modes in a clockwise direction or **DOWN** to cycle through the modes in an anti-clockwise direction.



Pressure and Weather Forecast Mode

- Current pressure, trend, and history bar-chart
- Weather forecast
- Moon phase

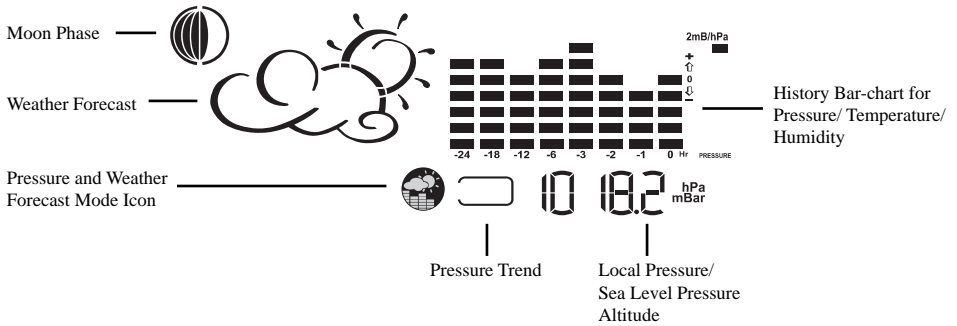

Clock and Alarm Mode

- Radio Controlled clock showing current time and calendar
- Single alarm, weekday alarm and pre-alarm





Sunrise/Sunset Mode

- Sunrise and sunset times
- Longitude and latitude of local area

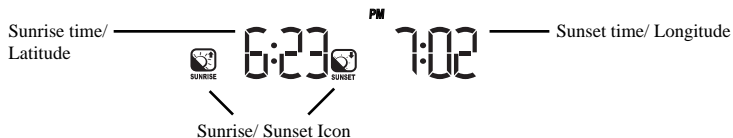

Temperature and Humidity Mode

- Temperature and humidity trend and readings for indoor and selected channel
- Comfort level
- Dew point
- Temperature alerts

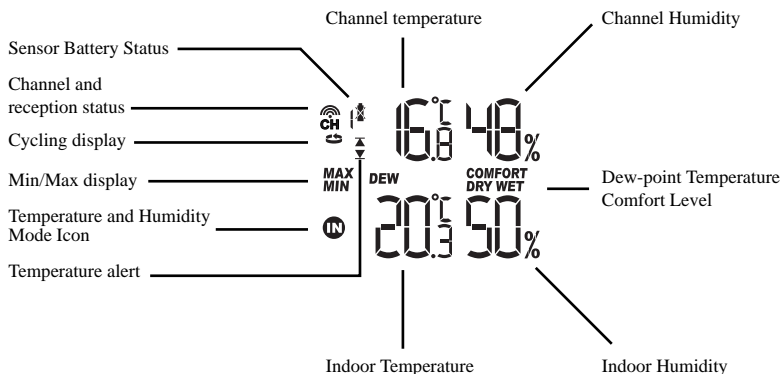

Rain Mode

- Precipitation amount for last hour, last 24 hour, yesterday, last week and last month
- Rainfall alert





Wind Mode

- Wind Chill
- Temperature at place of anemometer
- Wind direction
- Wind speed
- Wind gust
- Alert for wind speed and wind gust speed

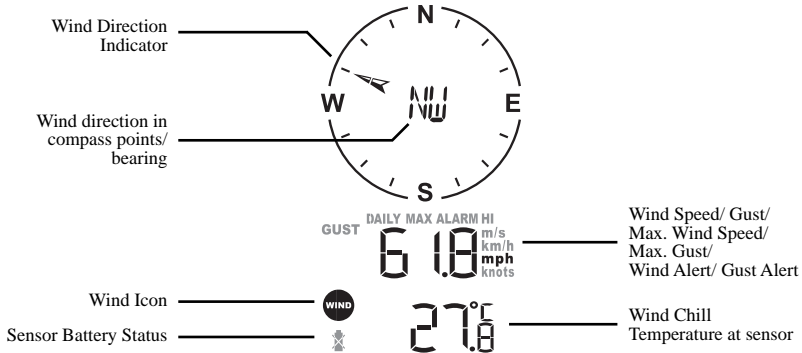

Customizing your Weather Center

To fully customize the weather center to your local settings and personal preferences, the following settings are required. Please refer to the appropriate sections for detailed instructions.

Required:

- Setting Pressure Parameters during Initial Start-Up (Pressure and Weather Forecast Mode)
- Setting up the Time, Date and Language (Clock and Alarm Mode)
- Setting up the Location Data (Sunrise/Sunset Mode)

Optional:

- Setting up the Time Alarms (Clock and Alarm Mode)
- Setting up the Temperature Alerts (Temperature and Humidity Mode)
- Setting up the Daily Rainfall Alerts (Rain Mode)
- Setting up the Wind Alerts (Winds Mode)

Using the Different Weather Modes

Pressure and Weather Forecast Mode

This part of the display indicates the current pressure, sea level pressure, weather forecast, moon phase and pressure trend.

A number of historical statistics can also be viewed, such as the sea-level pressure values for the last 24 hours, moon phase for the previous and next 39 days, as well as a pressure/ temperature/ humidity history bar-chart.

Pressure values may be displayed inHg, hPa/mbar or mmHg, and altitude values may be displayed in meters or feet.

Accessing Pressure and Weather Forecast Mode

From the main console unit: Press **UP** or **DOWN** until the weather forecast icon  in the middle of the display starts flashing.

Setting Pressure Parameters during Initial Start-Up

During the initial start-up of the main console unit, all functions in Pressure and Weather Forecast Mode will be locked until the pressure settings are configured.

1. Choose Pressure Units:

The unit icon “inHg” or “mmHg” or “hPa/mbar” should be flashing. Press **UP** or **DOWN** to select pressure unit as in Hg, hPa/mbar or mmHg

Press **SET** to confirm your selection.

2. Choose Altitude Units:

Press **UP** or **DOWN** to select altitude unit as feet or meters.

Press **SET** to confirm your selection.

3. Set Altitude:

Press **UP** or **DOWN** to adjust value. Press and hold either button for fast advance.

Press **SET** to confirm your selection.

4. Upon completion the display will be returned to Pressure and Weather Forecast Mode.

Note: After initial start-up the altitude cannot be adjusted again until the main console unit is restarted.

Viewing Pressure and Altitude Data

In Pressure and Weather Forecast Mode, each press of **SET** rotates display between:

- Sea-level pressure
- Local pressure
- Local altitude

Setting the Sea-Level Pressure

1. In Pressure and Weather Forecast Mode, press **SET** until the sea-level pressure is displayed.
2. Press and hold **SET**. The Sea-Level Pressure display should be flashing.
3. Set Sea-Level Pressure:
Press **UP** or **DOWN** to adjust value. Press and hold either button for fast advance.
Press **SET** to confirm your selection.
4. Upon completion the display will be returned to Pressure and Weather Forecast Mode.

Setting the Pressure and Altitude Units

1. In Pressure and Weather Forecast Mode, press **SET** until local pressure is displayed.
2. Press and hold **MEMORY**. The pressure unit should be flashing.
3. Set Local Pressure Units:
Press **UP** or **DOWN** to adjust value.
Press **SET** to confirm your selection.
4. Set Altitude Units:
Press **UP** or **DOWN** to adjust value.
Press **SET** to confirm your selection.
5. Set Sea-Level Pressure Units:
Press **UP** or **DOWN** to adjust value.
Press **MEMORY** to confirm your selection.
6. Upon completion the display will be returned to Pressure and Weather Forecast Mode.

Viewing the Sea Level Pressure History

1. In all modes, pressing **HISTORY** will toggle the sea level pressure display.
2. When sea level pressure is displayed, **press HISTORY** repeatedly to view sea level pressure data for each of the last 24 hours.
3. If no buttons are pressed for 5s, the display automatically returns to Pressure and Weather Forecast Mode.

Viewing the Pressure/ Temperature/ Humidity Bar-Charts

The bar-chart on the display can be configured to display the history data for sea-level pressure, temperature or humidity for channel 1.







In Pressure and Weather Forecast Mode, press and hold **ALARM/CHART** to toggle the bar-chart between:

- Sea-level pressure (“PRESSURE” should be displayed)
- Temperature (Thermometer icon and “CH1” should be displayed)
- Humidity (RH icon and “CH1” should be displayed)

Viewing Moon Phase History and Forecast

1. In Pressure and Weather Forecast Mode, press **MEMORY**.
2. “+ 0 days” should be flashing.
3. View Moon Phase History / Forecast:
Press **UP** or **DOWN** to choose number of days forward (+ days) or backward (- days) from current date. Press and hold either button for fast advance.
The corresponding moon phase will be shown.
4. To exit, press **MEMORY**.
Otherwise, if no buttons are pressed for 5s the display automatically returns to Pressure and Weather Forecast Mode.

Understanding the Weather Forecast Display

Display	Weather Forecast Status
	Sunny
	Partly Cloudy
	Cloudy
 	Rain or Heavy Rain
	Unstable Weather
	Snow

NOTE:

1. The accuracy of a general pressure-based weather forecast is about 70%.
2. The weather forecasts may not necessarily reflect the current situation.
3. The “Sunny” icon, as applies to night time, implies clear weather.

Understanding the Moon Phase Diagram



Fullmoon

decreasing moon

waxing moon

Clock and Alarm Mode

The main console unit can be configured to display the time, calendar or UTC time. There are three time alarms available on the console unit:

Single alarm: activated once at specified time

Weekday alarm: activated everyday from Monday to Friday at specified time

Pre-alarm: activated at specified time interval (30 min) ahead of weekday alarm, if channel 1 temperature falling to +2 °C or below.

The snooze duration for the above alarms can also be programmed (0-15 min).

Accessing Clock and Alarm Mode

From the main console unit: Press **UP** or **DOWN** until the clock icon  beside the time/date display starts flashing.

Setting up the Time, Date and Language

1. In Clock and Alarm Mode, press and hold **SET** to enter clock and calendar setup.
2. The day of week should start flashing in the display.
Set Language:
Press **UP** or **DOWN** to select language for day of week: English, German, French, Italian, Spanish or Dutch.
3. Select City Code:
Press **UP** or **DOWN** to select city code for your local area. Refer to P.63 for a list of available codes.
Press **SET** to confirm your selection.
4. (If USR was chosen for city code) Set Degree for Latitude:
You will be asked to enter your latitude in degrees (°).
Press **UP** or **DOWN** to adjust value. Press and hold either button for fast advance.
Press **SET** to confirm your selection. Repeat above procedure to set minutes and seconds for latitude, degrees for longitude, minutes for longitude and seconds for longitude.
5. (If USR was chosen for city code) Set Time Zone:
Press **UP** or **DOWN** to adjust value in resolution of 30 min. Press and hold either button for fast advance. Press **SET** to confirm your selection.
6. (If USR was chosen for city code or city is in a DST zone) Set Daylight Saving Time Option:
Press **UP** or **DOWN** to turn DST option on or off. Press and hold either button for fast advance.
Press **SET** to confirm your selection.
7. Repeat the above instructions to set year, month, day, calendar display format (day/month or month/day), time display format (12 hr / 24 hr), local hour and local minutes.
8. Upon completion the display will return to normal Clock and Alarm Mode.

Note: Press and hold **SET** anytime during the setup to return to normal Clock and Alarm Mode. All settings made will be discarded.

Rotating between Different Clock/Calendar Displays

In Clock and Alarm Mode, each press of **SET** rotates clock display between:

- Hour: Minute: Weekday
- Hour: Minute for UTC (Coordinated Universal Time)
- Hour: Minute: City
- Hour: Minute: Second
- Month: Day: Year (or Day: Month: Year depending on settings)

Activating/Deactivating the Time Alarms

1. In Clock and Alarm Mode, each press of **ALARM/CHART** rotates clock display between:
 - Weekday Alarm Time (displays OFF if weekday alarm deactivated)
 - Single Alarm Time (displays OFF if single alarm deactivated)
 - Pre-Alarm Time (displays OFF if pre-alarm deactivated)
2. When the above alarms are displayed, pressing **UP** or **DOWN** will activate/deactivate the corresponding alarm.

Note: Press **SET** anytime during alarm selection mode to return to normal clock display.

Setting up the Time Alarms

1. In Clock and Alarm Mode, press **ALARM/CHART** to select alarm which you wish to configure.
2. Press and hold **ALARM/CHART** until hour starts flashing in the display.
3. Set Alarm Hour:
 - Press **UP** or **DOWN** to adjust value. Press and hold either button for fast advance.
 - Press **ALARM/CHART** to confirm your selection.
4. Set Alarm Minutes:
 - Press **UP** or **DOWN** to adjust value. Press and hold either button for fast advance.
 - Press **ALARM/CHART** to confirm your selection.
5. Set Duration of Snooze Function (all three alarms share same snooze time duration):
 - Press **UP** or **DOWN** to adjust value. Press and hold either button for fast advance.
 - Press **ALARM/CHART** to confirm your selection.
6. Upon completion the display will be returned to the alarm selection screen.

Note: Pre-alarm cannot be activated if weekday alarm or single alarm is not enabled.

Disabling/Entering Snooze when Time Alarms are Activated

To Enter Snooze:

Press **SNOOZE** to enable snooze function.

Note: Alarm will automatically enter snooze mode if no key is pressed after the alarm sounds for 2 minutes. This will occur for a maximum of three times.

To Disable Alarm(s):

Press **ALARM/CHART** to disable the alarm(s).

Note: For weekday alarm, pressing **ALARM/CHART** will only disable the alarm for the current day. The alarm will be activated again the next day (if it falls within Monday to Friday).

Activating/Deactivating Radio Clock Reception





The main console unit synchronizes the time and date with radio clock broadcasts to maintain atomic clock precision.

To turn this function on/off:

Press and hold **UP**.

If RC reception is activated, a triangular tower icon will start flashing beside the clock icon.

If RC reception is deactivated, the triangular tower icon will disappear.

Icon	RC Reception Strength
 (Blinks)	Undefined data
	Reception failed for 24 hours
	Weak signal, but can be decoded
	Strong signal



Note: The radio controlled signal for time (DCF 77) is transmitted from the central atomic clock in Frankfurt/Main in short intervals. It has a reception range of approx. 1500 km. Obstructions such as concrete walls can reduce the signal range.

Sunrise/Sunset Mode

The main console unit computes the sunrise and sunset times from the user-configured location data. This includes the longitude, latitude, time zone and DST (Daylight Saving Time). Choosing a suitable city code for your area will automatically generate the correct values for the location data. Should you wish to input your own location data or if a suitable city code could not be found, choose “USR” as the city code during setup.

A searching function is also available, which allows the sunrise/sunset times for different dates to be viewed.

Accessing Sunrise/Sunset Mode

From the main console unit: Press **UP** or **DOWN** until the sunrise and sunset icons   of the display start flashing.

Setting up the Location Data

1. In Sunrise/Sunset Mode, press and hold **SET** to enter location data setup.
 2. The city code in the Time and Alarm Display should start flashing.
Set City Info:
Press **UP** or **DOWN** to select city code for your local area. The corresponding longitude and latitude will be shown along with the city.
Should you wish to input your own geographical coordinates, choose “USR” as the city code.
Press **SET** to confirm your selection.
 3. If “USR” was chosen, you will be asked to input your geographical coordinates.
Set Degree of Latitude:
Press **UP** or **DOWN** to adjust value. Press and hold either button for fast advance.
Press **SET** to confirm your selection.
 4. Repeat above procedure to set minute of latitude, degree of longitude, minute of longitude, time zone of the city, and DST selection.
 5. Upon completion the display will be returned to Sunrise/Sunset Mode.
- Note: Press and hold **SET** anytime during the setup to return to normal Clock and Alarm Mode. All settings made will be discarded.

Viewing the Location Data

In Sunrise/Sunset Mode, each press of **SET** rotates display between:

- Time and sunrise/ sunset times
- Calendar and sunrise/ sunset times
- Calendar and longitude/ latitude

Viewing Sunrise/Sunset Times for Different Dates

1. In Sunrise/Sunset Mode, press **MEMORY**.
2. The date should be flashing.
Press **UP** or **DOWN** to adjust date. Press and hold either button for fast advance.
The corresponding sunrise and sunset times will be displayed for the selected date.
3. Press **MEMORY** or **SET** to return display to Sunrise/Sunset Mode.

Understanding the Sunrise/Sunset Display

The sunrise time being displayed differs during the morning and the afternoon/night.

From 12 am to 12 pm: The sunrise time for the current day will be displayed.

From 12 pm to am: The sunrise time for the next day will be displayed. “NEXT DAY” icon will be displayed above the sunrise time.

At certain locations (especially those at high latitudes), sunrise and sunset events may not occur within a 24 hour time frame.

Display	Sunrise status	Display	Sunset status
FULL	Sunrise at previous day	FULL	Sunset at next day or later
----	No sunrise for the whole day	----	No sunset for the whole day

Temperature and Humidity Mode

The weather center supports up to 5 remote thermo-hygro sensors, each sensor corresponding to a separate channel for the temperature and relative humidity display. The temperature may be shown in degrees Celsius °C or degrees Fahrenheit °F. The trend (rising, steady or falling) of all values is also indicated on the display.

The main console unit uses the indoor temperature and humidity data to compute a comfort level rating of Wet, Comfort or Dry.

A temperature alert function is available for each channel. It can be programmed to sound if the channel temperature exceeds or falls below the pre-configured upper and lower limits.

Note: The temperature alerts have a 0.5 °C hysteresis to prevent the alerts from sounding constantly due to small fluctuations near the alert value. This means that after the temperature reaches the alert value, it will have to fall below the alert value plus the hysteresis to deactivate the alert.

Accessing Temperature and Humidity Mode

From the main console unit: Press **UP** or **DOWN** until the **IN** icon  of the display starts flashing.

Viewing Temperature and Humidity Display for each Channel

For Static Display:

In Temperature and Humidity Mode, each press of **CHANNEL** rotates display between different channels.

For Cycling Display:

To enable automatic rotating between different channel displays, press and hold **CHANNEL**, until the  icon is displayed. Each valid channel will now be alternately displayed for 5 s.

Rotating Between Temperature and Dew Point Display

In Temperature and Humidity Mode, each press of **SET** rotates temperature display between:

- Temperature and Relative Humidity
- Dew Point Temperature and Relative Humidity

Setting Units for Temperature Display (°C or °F)

In Temperature and Humidity Mode, press and hold **SET** to convert units between degrees Celsius °C and degrees Fahrenheit °F.

Activating/Deactivating the Temperature Alerts

- In Temperature and Humidity Mode, each press of **ALARM/CHART** rotates channel temperature display between:
 - Current Temperature for corresponding channel
 - Upper Temperature Alert (displays OFF if deactivated): ▲ icon displayed
 - Lower Temperature Alert (displays OFF if deactivated): ▼ icon displayed
- When the above alerts are displayed, pressing **UP** or **DOWN** will activate/deactivate the corresponding alert.

Setting up the Temperature Alerts

- In Temperature and Humidity Mode, press **ALARM/CHART** to select alarm which you wish to configure.
- Press and hold **ALARM/CHART** until channel temperature and ▲ or ▼ icon starts flashing in the display.
- Set Value for Temperature Alert:
 - Press **UP** or **DOWN** to adjust value. Press and hold either button for fast advance.
 - Press **ALARM/CHART** to confirm your selection.
- Upon completion the display will be returned to the temperature alert selection screen.

Disabling when Temperature Alarms are Activated

To Disable Temperature Alarm(s):

Press **ALARM/CHART** to disable the alarm (s).

Viewing the Max/Min Channel Temperature and Humidity

In Temperature and Humidity Mode, each press of **MEMORY** rotates channel temperature and humidity display between:



- Current temperature and humidity at remote sensor
- Minimum temperature and humidity at remote sensor
- Maximum temperature and humidity at remote sensor

Resetting the Max/Min Channel Temperature and Humidity Memory

In Temperature and Humidity Mode, press and hold **MEMORY** to clear memory for all channels.

Remote Sensor Status

The wave icon above the current channel display shows the connection status of the corresponding remote sensor:

Icon	Status
 (Blinks)	Searching for remote sensor signals
	Corresponding remote sensor successfully linked
•	No signals received for more than 15 minutes

Activating Main Console Unit to Search for All Remote Sensor Signals

The main console unit may be manually activated to search for signals from all remote sensors. Press and hold **DOWN** to enforce a search.

Rain Mode

The main console unit records the total amount of rainfall for the last hour, last 24 hours, yesterday, last week and last month. The rainfall may be displayed in mm or inches.

A daily rainfall alert function is available which can be programmed to sound if the daily rainfall exceeds a pre-configured limit.

Accessing Rain Mode

From the main console unit: Press **UP** or **DOWN** until the RAIN icon  on the display starts flashing.

Viewing Rain Statistics

In Rain Mode, each press of **SET** or **MEMORY** rotates display between different rain statistics:

- Last hour
- Last 24 hours
- Yesterday
- Last week
- Last month

Tip: For an estimation of the rain rate, the Last Hour rainfall value can be understood as “inch/hr” or “mm/hr”.

Resetting the Rainfall Statistics Memory

In Rain Mode, press and hold **MEMORY** to reset all rainfall statistics.

Setting Units for Rain Display (inch or mm)

In Rain Mode, press and hold **SET** to convert units between mm and inches.

Activating/Deactivating the Daily Rainfall Alert

1. In Rain Mode, each press of **ALARM/CHART** rotates display between the current rainfall statistics and the daily rainfall alert (“ALARM HI” will be displayed).
If the alert is deactivated, “OFF” will be shown, otherwise the rainfall alert value is shown.
2. When the rainfall alert is displayed, pressing **UP** or **DOWN** will activate/deactivate it.

Setting up the Daily Rainfall Alert

1. In Rain Mode, press **ALARM/CHART** to display rainfall alert.
2. Press and hold **ALARM/CHART** until rainfall alert and “ALARM HI” starts flashing in the display.
3. Set Value for Rainfall Alert:
Press **UP** or **DOWN** to adjust value. Press and hold either button for fast advance.
Press **ALARM/CHART** to confirm your selection.
4. Upon completion the display will be returned to the rainfall alert display.

Disabling when Daily Rainfall Alert is Activated

To disable Rainfall Alert:

Press **ALARM/CHART** to disable the alert.

Wind Mode

The wind direction is shown by an animated compass display. Its angle can be displayed as compass points (i.e. NW) or in bearings from the north (i.e. 22.5°).

The lower left of the wind display can be set to indicate the temperature at the anemometer or the temperature adjusted with a wind chill factor.

The upper left of the wind display indicates the average wind speed for the last 10 minutes, as well as gust, wind speed alert and gust alert information. It can also show records of the maximum values of wind speed and gust attained for the current day.

The wind speed and gust alert functions can be programmed to sound if the wind speed or gust exceeds a pre-configured limit. The wind speed may be displayed in km/h, mph, m/s or knots.

Note: The wind speed alert has a 5 mph hysteresis and the wind gust speed alert has a 7 mph hysteresis. The hysteresis is to prevent the alerts from sounding constantly due to small fluctuations near the alert value. This means that after the wind speed reaches the alert value, it will have to fall below the alert value plus the hysteresis to deactivate the alert.

Accessing Wind Mode

From the main console unit: Press **UP** or **DOWN** until the WIND icon  on the display starts flashing.

Configuring Wind Display

In Wind Mode, each press of **SET** rotates display between:

- Temperature with wind chill, wind direction in bearings
- Temperature with wind chill, wind direction in compass points
- Temperature at anemometer, wind direction in compass points
- Temperature at anemometer, wind direction in bearings

Setting Units for Wind Speed Display (km/h , mph, m/s or knots)

In Wind Mode, press and hold **SET** to convert wind speed units between km/h, mph, m/s or knots.

Viewing Wind Statistics

In Wind Mode, each press of **MEMORY** rotates wind speed display between:

- Current wind speed
- Daily maximum wind speed (“DAILY MAX” is displayed)
- Gust speed (“GUST” is displayed)
- Daily maximum gust speed (“GUST DAILY MAX” is displayed)

Resetting the Wind Statistics Memory

In Wind Mode, press and hold **MEMORY** to reset all wind statistics.

Activating/Deactivating Wind Alerts

1. In Wind Mode, each press of **ALARM/CHART** rotates wind speed display between:
 - Current wind speed
 - Wind speed alert (“ALARM HI” displayed)
 - Gust alert (“GUST ALARM HI” displayed)If the alert is deactivated, “OFF” will be shown, otherwise the alert value is shown.
2. When a wind alert is displayed, pressing **UP** or **DOWN** will activate/deactivate it.

Setting up the Wind Alerts

1. In Wind Mode, press **ALARM/CHART** to select alarm which you wish to configure.
2. Press and hold **ALARM/CHART** until alert and corresponding icon starts flashing in the display.
3. Set Value for Alert:
 - Press **UP** or **DOWN** to adjust value. Press and hold either button for fast advance.
 - Press **ALARM/CHART** to confirm your selection.
4. Upon completion the display will be returned to the wind alert selection screen.

Disabling when Wind Alert is Activated

To disable Wind Alert:

Press **ALARM/CHART** to disable the alert.

Maintenance

Changing Batteries

The battery statuses of the sensors are checked every hour. If the low battery indicators light up, replace the batteries for the corresponding unit immediately.

Changing Batteries for the Main Console Unit

1. Remove the latch at the back and replace all batteries. Do not mix old and new batteries.
2. Replace the Cover.

Changing Batteries for the Remote Sensors

1. Replace the batteries following the setup instructions for the corresponding sensor.
2. When the batteries are properly installed, the sensor will resume sending signals to the main console unit.
To enforce a search immediately for all remote signals, press and hold **DOWN** on the main console unit.

Cleaning

The main console unit and outer casings for the remote sensors can be cleaned with a damp cloth.

Small parts can be cleaned with a cotton tip or pipe-cleaner.

Never use any abrasive cleaning agents and solvents. Do not immerse any units with electronic parts in water or under running water.

Anemometer

- Check that the wind vane and wind cups can spin freely and are free from dirt, debris or spider webs.

Rain Sensor

Like all rain gauges, the rain sensor is prone to blockages due to its funnel shape. Checking and cleaning the rain sensor from time to time will maintain the accuracy of rain measurements.

- Detach the protective screen and lid. Remove any dirt, leaves or debris by cleaning the items with soapy water and a damp cloth. Clean small holes and parts with a cotton tips or pipe-cleaner.
- Look out for spiders or insects that might have crawled into the funnel.
- Also clean the swinging mechanism with a damp cloth.

Troubleshooting

The display shows dashes “---” for weather parameter(s)

The display will show “---” when the wireless link with the remote is lost sensor for the following periods:

Thermo-hygro Sensor	– 15 minutes
Anemometer (Wind Sensor)	– 15 minutes
Rain Sensor	– 30 minutes

Check or replace the batteries for the corresponding sensor. Then press and hold **DOWN** to enforce a search for all remote signals.

If the above does not solve the problem, check the wireless transmission path from the corresponding sensor to the main console unit and change their locations if necessary. Although wireless signals can pass through solid objects and walls, the sensor should ideally be within the line of sight of the console unit.

The following may be the cause of reception problems:

- Distance between remote sensor and main console unit too long. (Maximum transmission distance in open area conditions is 100 m.)
- Signal shielding materials such as metal surfaces, concrete walls or dense vegetation in the path of transmission.
- Interferences from wireless devices (such as cordless phones, radio headsets, baby listening devices) and electronic appliances.

The weather readings do not correlate with measurements from TV, radio or official weather reports

Weather data can vary considerably due to different environmental conditions and placement of weather sensors.

Check the placement tips included in this manual to site your sensors in the best possible way.

The weather forecast is inaccurate

The weather forecast is a prediction of weather after 12-24 hours, and may not reflect current weather conditions.

PRECAUTIONS

This product is engineered to give you years of satisfactory service if you handle it carefully. Here are a few precautions:

1. Do not immerse the unit in water.
2. Do not clean the unit with abrasive or corrosive materials. They may scratch the plastic parts and corrode the electronic circuit.
3. Do not subject the unit to excessive force, shock, dust, temperature or humidity, which may result in malfunction, shorter electronic life span, damaged battery and distorted parts.
4. Do not tamper with the unit’s internal components. Doing so will invalidate the warranty on the unit and may cause unnecessary damage. The unit contains no user-serviceable parts.
5. Only use fresh batteries as specified in the user’s manual. Do not mix new and old batteries as the old ones may leak.
6. Always read the user’s manual thoroughly before operating the unit.

CAUTION

- The content of this manual is subject to change without further notice.
- Due to printing limitation, the displays shown in this manual may differ from the actual display.
- The contents of this manual may not be reproduced without the permission of the manufacturer.

Remark: The front side of the casing shows, under certain angles, 2 flow lines. These flow lines are caused by the production process of the casing and, unfortunately, are unavoidable. They have, however, no effect whatsoever on the operation of the device.

EEC-DECLARATION OF CONFORMITY

Product : BRESSER Weather Center

Bresser GmbH declares that the device (Weather station/
Art.No.: 70-02500) is in accordance with applicable guidelines and corresponding standards of the 1999/5/EG directive.

Bresser GmbH has issued a “Declaration of Conformity” in accordance with applicable guidelines and corresponding standards. This can be viewed any time upon request.

Power
 Main unit : use 4 pcs UM-3 or "AA" 1.5 V battery
 Remote Thermo-hygro unit : use 2 pcs UM-3 or "AA" 1.5 V battery
 Remote Anemometer unit : use 2 pcs UM-3 or "AA" 1.5 V battery
 Remote Rain gauge unit : use 2 pcs UM-3 or "AA" 1.5 V battery

Weight
 Main unit : 541g (without battery)
 Remote Thermo.-Hygro unit : 69g (without battery)
 Remote Anemometer unit : 315g (without battery)
 Remote Rain gauge unit : 300g (without battery)

Dimension
 Main unit : 148(L) x 193(H) x 39(D) mm
 Remote Thermo-hygro unit : 55.5(L) x 101(H) x 24(D) mm
 Remote Anemometer unit : 405(L) x 375(H) x 160(D) mm
 Remote Rain gauge unit : 163(L) x 177(H) x 119(D) mm

Appendix

City Codes

US and Canadian Cities

City	Code	Zone Offset	DST	City	Code	Zone Offset	DST
Atlanta, Ga.	ATL	-5	SU	Memphis, Tenn.	MEM	-6	SU
Austin, Tex.	AUS	-6	SU	Miami, Fla.	MIA	-5	SU
Baltimore, Md.	BWI	-5	SU	Milwaukee, Wis.	MKE	-6	SU
Birmingham, Ala.	BHM	-6	SU	Minneapolis, Minn.	MSP	-6	SU
Boston, Mass.	BOS	-5	SU	Montreal, Que., Can.	YMX	-5	SU
Calgary, Alba., Can.	YYC	-7	SU	Nashville, Tenn.	BNA	-6	SU
Chicago, IL	CGX	-6	SU	New Orleans, La.	MSY	-6	SU
Cincinnati, Ohio	CVG	-5	SU	New York, N.Y.	NYC	-5	SU
Cleveland, Ohio	CLE	-5	SU	Oklahoma City, Okla.	OKC	-6	SU
Columbus, Ohio	CMH	-5	SU	Omaha, Neb.	OMA	-6	SU
Dallas, Tex.	DAL	-6	SU	Ottawa, Ont., Can.	YOW	-5	SU
Denver, Colo.	DEN	-7	SU	Philadelphia, Pa.	PHL	-5	SU
Detroit, Mich.	DTW	-5	SU	Phoenix, Ariz.	PHX	-7	NO
El Paso, Tex.	ELP	-7	SU	Pittsburgh, Pa.	PIT	-5	SU
Houston, Tex.	HOU	-6	SU	Portland, Ore.	PDX	-8	SU
Indianapolis, Ind.	IND	-5	NO	San Antonio, Tex.	SAT	-6	SU
Jacksonville, Fla.	JAX	-5	SU	San Diego, Calif.	SAN	-8	SU
Las Vegas, Nev.	LAS	-8	SU	San Francisco, Calif.	SFO	-8	SU
Los Angeles, Calif.	LAX	-8	SU	San Jose, Calif.	SJC	-8	SU

DST definition

SA = Australian DST. / **SB** = South Brazilian DST. Changes annually. / **SC** = Chile DST / **SE** = Standard European DST.
SG = Egypt DST / **SH** = Havana, Cuba DST / **SI** = Iraq and Syria DST / **SK** = Irkutsk & Moscow DST / **SM** = Montevideo, Uruguay DST
SN = Namibia DST / **SP** = Paraguay DST / **SQ** = Iran DST maybe changed annually. / **ST** = Tasmania DST / **SU** = Standard American
 DST. / **SZ** = New Zealand DST / **NO DST** = no = Places that do not observe DST / **ON** = Always add 1 hour with local standard time

World Cities

City	Code	Zone Offset	DST	City	Code	Zone Offset	DST
Addis Ababa, Ethiopia	ADD	3	NO	Cairo, Egypt	CAI	2	SG
Adelaide, Australia	ADL	9.5	SA	Calcutta, India (as Kolkata)	CCU	5.5	NO
Algiers, Algeria	ALG	1	NO	Cape Town, South Africa	CPT	2	NO
Amsterdam, Netherlands	AMS	1	SE	Caracas, Venezuela	CCS	-4	NO
Ankara, Turkey	AKR	2	SE	Chihuahua, Mexico	CUU	-6	SU
Asunción, Paraguay	ASU	-3	sp	Copenhagen, Denmark	CPH	1	SE
Athens, Greece	ATH	2	SE	Córdoba, Argentina	COR	-3	NO
Bangkok, Thailand	BKK	7	NO	Dakar, Senegal	DKR	0	NO
Barcelona, Spain	BCN	1	SE	Dublin, Ireland	DUB	0	SE
Beijing, China	BEJ	8	NO	Durban, South Africa	DUR	2	NO
Belgrade, Yugoslavia	BEG	1	SE	Frankfurt, Germany	FRA	1	SE
Berlin, Germany	BER	1	SE	Glasgow, Scotland	GLA	0	SE
Birmingham, England	BHX	0	SE	Guatemala City, Guatemala	GUA	-6	NO
Bogotá, Colombia	BOG	-5	NO	Hamburg, Germany	HAM	1	SE
Bordeaux, France	BOD	1	SE	Havana, Cuba	HAV	-5	SH
Bremen, Germany	BRE	1	SE	Helsinki, Finland	HEL	2	SE
Brisbane, Australia	BNE	10	NO	Hong Kong, China	HKG	8	NO
Brussels, Belgium	BRU	1	SE	Irkutsk, Russia	IKT	8	SK
Bucharest, Romania	BBU	2	SE	Jakarta, Indonesia	JKT	7	NO
Budapest, Hungary	BUD	1	SE	Johannesburg, South Africa	JNB	2	NO
Buenos Aires, Argentina	BUA	-3	NO	Kingston, Jamaica	KIN	-5	NO

City	Code	Time Zone	DST	City	Code	Time	DST
Kinshasa, Congo	FIH	1	NO	Oslo, Norway	OSL	1	SE
Kuala Lumpur, Malaysia	KUL	8	NO	Panama City, Panama	PTY	-5	NO
La Paz, Bolivia	LPB	-4	NO	Paris, France	PAR	1	SE
Lima, Peru	LIM	-5	NO	Perth, Australia	PER	8	NO
Lisbon, Portugal	LIS	0	SE	Prague, Czech Republic	PRG	1	SE
Liverpool, England	LPL	0	SE	Rangoon, Myanmar	RGN	6.5	NO
London, England	LON	0	SE	Reykjavik, Iceland	RKV	0	NO
Lyon, France	LYO	1	SE	Rio de Janeiro, Brazil	RIO	-3	SB
Madrid, Spain	MAD	1	SE	Rome, Italy	ROM	1	SE
Manila, Philippines	MNL	8	NO	Salvador, Brazil	SSA	-3	NO
Marseille, France	MRS	1	SE	Santiago, Chile	SCL	-4	SC
Melbourne, Australia	MEL	10	SA	São Paulo, Brazil	SPL	-3	SB
Mexico City, Mexico	MEX	-6	SU	Shanghai, China	SHA	8	NO
Milan, Italy	MIL	1	SE	Singapore, Singapore	SIN	8	NO
Montevideo, Uruguay	MVD	-3	SM	Sofia, Bulgaria	SOF	2	SE
Moscow, Russia	MOW	3	SK	Stockholm Arlanda, Sweden	ARN	1	SE
Munich, Germany	MUC	1	SE	Sydney, Australia	SYD	10	SA
Nairobi, Kenya	NBO	3	NO	Tokyo, Japan	TKO	9	NO
Nanjing (Nanking), China	NKG	8	NO	Tripoli, Libya	TRP	2	NO
Naples, Italy	NAP	1	SE	Vienna, Austria	VIE	1	SE
New Delhi, India	DEL	5.5	NO	Warsaw, Poland	WAW	1	SE
Odessa, Ukraine	ODS	2	SE	Zürich, Switzerland	ZRH	1	SE
Osaka, Japan	KIX	9	NO				

Technical Specifications

Weather Center Receivers

Receiver	(Supply=6.0V, Ta=23°C)
Sensor unit	(Supply=3.0V, Ta=23°C)
RF Transmission Frequency	434 MHz
RF Reception Range	100 meters Maximum (Line of Sight)
Barometric Pressure Range (At sea level)	500 hpa to 1100hpa (14.75 inHg to 32.44 inHg), (374.5 mmHg to 823.8 mmHg)
Altitude Compensation Range	-200m to +5000 m (-657 ft to 16404 ft)
Barometric Pressure Resolution	0.1 hpa (0.003 inHg, 0.08 mmHg)
Barometric Pressure Accuracy	+/- 5 hpa (0.015 inHg, 0.38 mmHg)
Outdoor Temperature Display Range	-40°C to 80°C (-40°F to 176°F)
Indoor Temperature Display Range	-9.9°C to 60°C (14.2°F to 140°F)
Operating Temperature	0°C to 50°C (32°F to 122°F)
Storage Temperature	-20°C to 60°C (-4°F to 140°F)
Temperature Accuracy	+/- 1°C or +/- 2°F
Temperature Resolution	0.1°C or 0.2°F
Humidity Display Range	0% to 99%
Humidity Accuracy	+/-5%
Humidity Resolution	1%
Receiving Cycle	
Remote Thermo-Hygro-Sensor	around 47s
Rain Gauge	183s
Wind Sensor	33s
Sunrise and Sunset Accuracy	+/- 3min (latitude within +/- 50°)
Wind Direction Range	16 positions
Wind Direction Accuracy	+/-11.25°
Wind Direction Resolution	22.5°
Wind Direction Starting Threshold	3mph
Wind Speed Range	0 to 199.9mph (199.9 Km/h, 173.7 Knots, 89.3 m/s)
Wind Speed Accuracy	+/- (2mph + 5%)
Wind Speed Starting Threshold	3mph
Wind/Gust Speed Display Update Interval	33 seconds
Wind/Gust Sampling Interval	11 seconds
1h/24h/yesterday Rainfall Range	0.0 to 1999.9 mm (78.73 inch)
Last week/ last month Rainfall Range	0 to 19999 mm (787.3 inch)
Temperature Sensing Cycle (indoor)	10s
Humidity Sensing Cycle (indoor)	10s

WARRANTY & SERVICE

The regular guarantee period is 2 years and begins on the day of purchase. To benefit from an extended voluntary guarantee period as stated on the gift box, registration on our website is required. You can consult the full guarantee terms as well as information on extending the guarantee period and details of our services at www.bresser.de/warranty_terms. Would you like detailed instructions for this product in a particular language? Then visit our website via the link below (QR code) for available versions. Alternatively you can also send an email to manuals@bresser.de or leave a message on +49 (0) 28 72 – 80 74-220*. Please always state your name, precise address, a valid phone number and email address, as well as the article number and name.

*Lokale Rufnummer in Deutschland (Die Höhe der Gebühren je Telefonat ist abhängig vom Tarif Ihres Telefonanbieters); Anrufe aus dem Ausland sind mit höheren Kosten verbunden.





Bresser GmbH
DE-46414 Rhede/Westf.
Germany

www.bresser.de